

Linking Lines

Oleg Viro

November 2, 2006

Can lines be linked?

- Can lines be linked?

- Combing lines
- No parallel lines
- Equivalence of links made of skew lines
- Pair of lines
- Orientations and Semi-Orientations
- Linking number
- Triples of lines
- Parallelepiped
- Deforming parallelepiped
- Linking number of a triple

Amphicheiral and
Nonamphicheiral

Is it possible to **weave** together disjoint lines?

Can lines be linked?

- Can lines be linked?

- Combing lines
- No parallel lines
- Equivalence of links made of skew lines
- Pair of lines
- Orientations and Semi-Orientations
- Linking number
- Triples of lines
- Parallelepiped
- Deforming parallelepiped
- Linking number of a triple

Amphicheiral and
Nonamphicheiral

Is it possible to **weave** together disjoint lines?

At first glance this may seem **not** to be possible.

Can lines be linked?

- Can lines be linked?

- Combing lines
- No parallel lines
- Equivalence of links made of skew lines
- Pair of lines
- Orientations and Semi-Orientations
- Linking number
- Triples of lines
- Parallelepiped
- Deforming parallelepiped
- Linking number of a triple

Amphicheiral and
Nonamphicheiral

Is it possible to **weave** together disjoint lines?

At first glance this may seem **not** to be possible.

Yet where do we get this impression? In daily life we never come across anything that really resembles a straight line.

Can lines be linked?

- Can lines be linked?

- Combing lines
- No parallel lines
- Equivalence of links made of skew lines
- Pair of lines
- Orientations and Semi-Orientations
- Linking number
- Triples of lines
- Parallelepiped
- Deforming parallelepiped
- Linking number of a triple

Amphicheiral and
Nonamphicheiral

Is it possible to **weave** together disjoint lines?

At first glance this may seem **not** to be possible.

Yet where do we get this impression? In daily life we never come across anything that really resembles a straight line.

Any set of disjoint **line segments** can be moved around to any other relative location in such a way that they remain disjoint.

Can lines be linked?

- Can lines be linked?

- Combing lines
- No parallel lines
- Equivalence of links made of skew lines
- Pair of lines
- Orientations and Semi-Orientations
- Linking number
- Triples of lines
- Parallelepiped
- Deforming parallelepiped
- Linking number of a triple

Amphicheiral and
Nonamphicheiral

Is it possible to **weave** together disjoint lines?

At first glance this may seem **not** to be possible.

Yet where do we get this impression? In daily life we never come across anything that really resembles a straight line.

Any set of disjoint **line segments** can be moved around to any other relative location in such a way that they remain disjoint.

Thus, **disjoint line segments cannot be linked.**

Can lines be linked?

- Can lines be linked?

- Combing lines
- No parallel lines
- Equivalence of links made of skew lines
- Pair of lines
- Orientations and Semi-Orientations
- Linking number
- Triples of lines
- Parallelepiped
- Deforming parallelepiped
- Linking number of a triple

Amphicheiral and
Nonamphicheiral

Is it possible to **weave** together disjoint lines?

At first glance this may seem **not** to be possible.

Yet where do we get this impression? In daily life we never come across anything that really resembles a straight line. Any set of disjoint **line segments** can be moved around to any other relative location in such a way that they remain disjoint.

Thus, **disjoint line segments cannot be linked.**

Can a set of disjoint lines be *rearranged*?

Can lines be linked?

- Can lines be linked?

- Combing lines
- No parallel lines
- Equivalence of links made of skew lines
- Pair of lines
- Orientations and Semi-Orientations
- Linking number
- Triples of lines
- Parallelepiped
- Deforming parallelepiped
- Linking number of a triple

Amphicheiral and Nonamphicheiral

Is it possible to **weave** together disjoint lines?

At first glance this may seem **not** to be possible.

Yet where do we get this impression? In daily life we never come across anything that really resembles a straight line. Any set of disjoint **line segments** can be moved around to any other relative location in such a way that they remain disjoint. Thus, **disjoint line segments cannot be linked.**

Can a set of disjoint lines be *rearranged*

by a continuous movement during which they stay disjoint?

Any two sets of parallel lines with the same number of lines in each set **can be transformed to each other** in this sense.

Combing lines

- Can lines be linked?
- **Combing lines**
- No parallel lines
- Equivalence of links made of skew lines
- Pair of lines
- Orientations and Semi-Orientations
- Linking number
- Triples of lines
- Parallelepiped
- Deforming parallelepiped
- Linking number of a triple

Amphicheiral and
Nonamphicheiral

Can an arbitrary set of lines be moved (“combed”) into a set of parallel lines?

Combing lines

- Can lines be linked?
- **Combing lines**
- No parallel lines
- Equivalence of links made of skew lines
- Pair of lines
- Orientations and Semi-Orientations
- Linking number
- Triples of lines
- Parallelepiped
- Deforming parallelepiped
- Linking number of a triple

Amphicheiral and
Nonamphicheiral

Choose two parallel planes which are not parallel to any of the lines in our set.

Combing lines

- Can lines be linked?
- **Combing lines**
- No parallel lines
- Equivalence of links made of skew lines
- Pair of lines
- Orientations and Semi-Orientations
- Linking number
- Triples of lines
- Parallelepiped
- Deforming parallelepiped
- Linking number of a triple

Amphicheiral and
Nonamphicheiral

Choose two parallel planes which are not parallel to any of the lines in our set.

Fix the points of intersection of the first plane with the lines, by fastening the lines at those points.

Combing lines

- Can lines be linked?
- **Combing lines**
- No parallel lines
- Equivalence of links made of skew lines
- Pair of lines
- Orientations and Semi-Orientations
- Linking number
- Triples of lines
- Parallelepiped
- Deforming parallelepiped
- Linking number of a triple

Amphicheiral and
Nonamphicheiral

Choose two parallel planes which are not parallel to any of the lines in our set.

Fix the points of intersection of the first plane with the lines.
Also fix the intersection of the lines with the second plane.

Combing lines

- Can lines be linked?
- **Combing lines**
- No parallel lines
- Equivalence of links made of skew lines
- Pair of lines
- Orientations and Semi-Orientations
- Linking number
- Triples of lines
- Parallelepiped
- Deforming parallelepiped
- Linking number of a triple

Amphicheiral and
Nonamphicheiral

Choose two parallel planes which are not parallel to any of the lines in our set.

Fix the points of intersection of the first plane with the lines. Also fix the intersection of the lines with the second plane, but only as a point on that plane, which we allow to slide along the lines.

Combing lines

- Can lines be linked?
- **Combing lines**
- No parallel lines
- Equivalence of links made of skew lines
- Pair of lines
- Orientations and Semi-Orientations
- Linking number
- Triples of lines
- Parallelepiped
- Deforming parallelepiped
- Linking number of a triple

Amphicheiral and
Nonamphicheiral

Choose two parallel planes which are not parallel to any of the lines in our set.

Fix the points of intersection of the first plane with the lines.

Also fix the intersection of the lines with the second plane.

In other words, drill small holes in the second plane where it intersects with the lines.

Combing lines

- Can lines be linked?
- **Combing lines**
- No parallel lines
- Equivalence of links made of skew lines
- Pair of lines
- Orientations and Semi-Orientations
- Linking number
- Triples of lines
- Parallelepiped
- Deforming parallelepiped
- Linking number of a triple

Amphicheiral and
Nonamphicheiral

Choose two parallel planes which are not parallel to any of the lines in our set.

Fix the points of intersection of the first plane with the lines.

Also fix the intersection of the lines with the second plane

Move the second plane away from the first one in the direction perpendicular to both planes.

Combing lines

- Can lines be linked?
- **Combing lines**
- No parallel lines
- Equivalence of links made of skew lines
- Pair of lines
- Orientations and Semi-Orientations
- Linking number
- Triples of lines
- Parallelepiped
- Deforming parallelepiped
- Linking number of a triple

Amphicheiral and
Nonamphicheiral

Choose two parallel planes which are not parallel to any of the lines in our set.

Fix the points of intersection of the first plane with the lines.

Also fix the intersection of the lines with the second plane

Move the second plane away from the first one in the direction perpendicular to both planes.

The lines are pulled through the holes

Combing lines

- Can lines be linked?
- **Combing lines**
- No parallel lines
- Equivalence of links made of skew lines
- Pair of lines
- Orientations and Semi-Orientations
- Linking number
- Triples of lines
- Parallelepiped
- Deforming parallelepiped
- Linking number of a triple

Amphicheiral and
Nonamphicheiral

Choose two parallel planes which are not parallel to any of the lines in our set.

Fix the points of intersection of the first plane with the lines.

Also fix the intersection of the lines with the second plane

Move the second plane away from the first one in the direction perpendicular to both planes.

The lines are pulled through the holes, their angles with the planes increase.

Combing lines

- Can lines be linked?
- **Combing lines**
- No parallel lines
- Equivalence of links made of skew lines
- Pair of lines
- Orientations and Semi-Orientations
- Linking number
- Triples of lines
- Parallelepiped
- Deforming parallelepiped
- Linking number of a triple

Amphicheiral and
Nonamphicheiral

Choose two parallel planes which are not parallel to any of the lines in our set.

Fix the points of intersection of the first plane with the lines.

Also fix the intersection of the lines with the second plane

Move the second plane away from the first one in the direction perpendicular to both planes.

The lines are pulled through the holes, their angles with the planes increase.

Move the second plane to infinity in a finite amount of time, then these angles all reach 90° , i.e., the lines become parallel to one another.

Combing lines

- Can lines be linked?
- **Combing lines**
- No parallel lines
- Equivalence of links made of skew lines
- Pair of lines
- Orientations and Semi-Orientations
- Linking number
- Triples of lines
- Parallelepiped
- Deforming parallelepiped
- Linking number of a triple

Amphicheiral and
Nonamphicheiral

Choose two parallel planes which are not parallel to any of the lines in our set.

Fix the points of intersection of the first plane with the lines.

Also fix the intersection of the lines with the second plane

Move the second plane away from the first one in the direction perpendicular to both planes.

The lines are pulled through the holes, their angles with the planes increase.

Move the second plane to infinity in a finite amount of time, then these angles all reach 90° , i.e., the lines become parallel to one another.

Another description: expand the space away from the first plane in a direction perpendicular to it, driving the expansion factor rapidly to infinity in a finite length of time.

Combing lines

- Can lines be linked?
- **Combing lines**
- No parallel lines
- Equivalence of links made of skew lines
- Pair of lines
- Orientations and Semi-Orientations
- Linking number
- Triples of lines
- Parallelepiped
- Deforming parallelepiped
- Linking number of a triple

Amphicheiral and
Nonamphicheiral

Choose two parallel planes which are not parallel to any of the lines in our set.

Fix the points of intersection of the first plane with the lines.

Also fix the intersection of the lines with the second plane

Move the second plane away from the first one in the direction perpendicular to both planes.

The lines are pulled through the holes, their angles with the planes increase.

Move the second plane to infinity in a finite amount of time, then these angles all reach 90° , i.e., the lines become parallel to one another.

Another description: expand the space away from the first plane in a direction perpendicular to it, driving the expansion factor rapidly to infinity in a finite length of time. The lines rotate around their points of intersection with the first plane, and in the limit become perpendicular to the planes.

No parallel lines

- Can lines be linked?
- Combing lines
- **No parallel lines**
- Equivalence of links made of skew lines
- Pair of lines
- Orientations and Semi-Orientations
- Linking number
- Triples of lines
- Parallelepiped
- Deforming parallelepiped
- Linking number of a triple

Amphicheiral and
Nonamphicheiral

Thus, one cannot link disjoint lines:

all sets of disjoint lines are arranged in the same way.

No parallel lines

- Can lines be linked?
- Combing lines
- **No parallel lines**
- Equivalence of links made of skew lines
- Pair of lines
- Orientations and Semi-Orientations
- Linking number
- Triples of lines
- Parallelepiped
- Deforming parallelepiped
- Linking number of a triple

Amphicheiral and
Nonamphicheiral

Thus, one cannot link disjoint lines:

all sets of disjoint lines are arranged in the same way.

However, there are serious **reasons for disqualifying** this result.

No parallel lines

- Can lines be linked?
- Combing lines
- **No parallel lines**
- Equivalence of links made of skew lines
- Pair of lines
- Orientations and Semi-Orientations
- Linking number
- Triples of lines
- Parallelepiped
- Deforming parallelepiped
- Linking number of a triple

Amphicheiral and
Nonamphicheiral

Thus, one cannot link disjoint lines:

all sets of disjoint lines are arranged in the same way.

However, there are serious **reasons for disqualifying** this result.

First, it was too easy.

No parallel lines

- Can lines be linked?
- Combing lines
- **No parallel lines**
- Equivalence of links made of skew lines
- Pair of lines
- Orientations and Semi-Orientations
- Linking number
- Triples of lines
- Parallelepiped
- Deforming parallelepiped
- Linking number of a triple

Amphicheiral and
Nonamphicheiral

Thus, one cannot link disjoint lines:

all sets of disjoint lines are arranged in the same way.

However, there are serious **reasons for disqualifying** this result.

First, it was **too easy**.

Second, parallel lines are very close to being intersecting:

No parallel lines

- Can lines be linked?
- Combing lines
- **No parallel lines**
- Equivalence of links made of skew lines
- Pair of lines
- Orientations and Semi-Orientations
- Linking number
- Triples of lines
- Parallelepiped
- Deforming parallelepiped
- Linking number of a triple

Amphicheiral and
Nonamphicheiral

Thus, one cannot link disjoint lines:

all sets of disjoint lines are arranged in the same way.

However, there are serious **reasons for disqualifying** this result.

First, it was **too easy**.

Second, parallel lines are very **close** to being intersecting: one can rotate one of two parallel lines by an arbitrarily small angle to make them intersect.

No parallel lines

- Can lines be linked?
- Combing lines
- **No parallel lines**
- Equivalence of links made of skew lines
- Pair of lines
- Orientations and Semi-Orientations
- Linking number
- Triples of lines
- Parallelepiped
- Deforming parallelepiped
- Linking number of a triple

Amphicheiral and
Nonamphicheiral

Thus, one cannot link disjoint lines:

all sets of disjoint lines are arranged in the same way.

However, there are serious **reasons for disqualifying** this result.

First, it was **too easy**.

Second, parallel lines are very **close** to being intersecting: one can rotate one of two parallel lines by an arbitrarily small angle to make them intersect. This is **not** the case for skew lines.

No parallel lines

- Can lines be linked?
- Combing lines
- **No parallel lines**
- Equivalence of links made of skew lines
- Pair of lines
- Orientations and Semi-Orientations
- Linking number
- Triples of lines
- Parallelepiped
- Deforming parallelepiped
- Linking number of a triple

Amphicheiral and
Nonamphicheiral

Thus, one cannot link disjoint lines:

all sets of disjoint lines are arranged in the same way.

However, there are serious **reasons for disqualifying** this result.

First, it was **too easy**.

Second, parallel lines are very **close** to being intersecting: one can rotate one of two parallel lines by an arbitrarily small angle to make them intersect. This is **not** the case for skew lines.

Third, parallel lines intersect in the **projective space**.

No parallel lines

- Can lines be linked?
- Combing lines
- **No parallel lines**
- Equivalence of links made of skew lines
- Pair of lines
- Orientations and Semi-Orientations
- Linking number
- Triples of lines
- Parallelepiped
- Deforming parallelepiped
- Linking number of a triple

Amphicheiral and
Nonamphicheiral

Thus, one cannot link disjoint lines:

all sets of disjoint lines are arranged in the same way.

However, there are serious **reasons for disqualifying** this result.

First, it was **too easy**.

Second, parallel lines are very **close** to being intersecting: one can rotate one of two parallel lines by an arbitrarily small angle to make them intersect. This is **not** the case for skew lines.

Third, parallel lines intersect in the **projective space**.

Let us decide **not to allow parallel lines anymore!**

Equivalence of links made of skew lines

- Can lines be linked?
- Combing lines
- No parallel lines
- Equivalence of links made of skew lines
- Pair of lines
- Orientations and Semi-Orientations
- Linking number
- Triples of lines
- Parallelepiped
- Deforming parallelepiped
- Linking number of a triple

Amphicheiral and
Nonamphicheiral

We say that the linking of a set of lines *remains the same* if it is moved in such a way that the lines are always skew, never intersect and never parallel.

Equivalence of links made of skew lines

- Can lines be linked?
- Combing lines
- No parallel lines
- Equivalence of links made of skew lines
- Pair of lines
- Orientations and Semi-Orientations
- Linking number
- Triples of lines
- Parallelepiped
- Deforming parallelepiped
- Linking number of a triple

Amphicheiral and Nonamphicheiral

We say that the linking of a set of lines *remains the same* if it is moved in such a way that the lines are always skew. Such movements of lines is called an *isotopy*.

Equivalence of links made of skew lines

- Can lines be linked?
- Combing lines
- No parallel lines
- **Equivalence of links made of skew lines**
- Pair of lines
- Orientations and Semi-Orientations
- Linking number
- Triples of lines
- Parallelepiped
- Deforming parallelepiped
- Linking number of a triple

Amphicheiral and
Nonamphicheiral

We say that the linking of a set of lines *remains the same* if it is moved in such a way that the lines are always skew. Such movements of lines is called an *isotopy*. If one set of lines can be obtained from another by an isotopy, then the two sets are *isotopic*.

Pair of lines

- Can lines be linked?
- Combing lines
- No parallel lines
- Equivalence of links made of skew lines
- **Pair of lines**
- Orientations and Semi-Orientations
- Linking number
- Triples of lines
- Parallelepiped
- Deforming parallelepiped
- Linking number of a triple

Amphicheiral and
Nonamphicheiral

Theorem. *Any two pairs of skew lines are isotopic.*

Pair of lines

- Can lines be linked?
- Combing lines
- No parallel lines
- Equivalence of links made of skew lines
- **Pair of lines**
- Orientations and Semi-Orientations
- Linking number
- Triples of lines
- Parallelepiped
- Deforming parallelepiped
- Linking number of a triple

Amphicheiral and
Nonamphicheiral

Theorem. *Any two pairs of skew lines are isotopic.*

Proof. Move any pair of skew lines to a standard pair:

Pair of lines

- Can lines be linked?
- Combing lines
- No parallel lines
- Equivalence of links made of skew lines
- **Pair of lines**
- Orientations and Semi-Orientations
- Linking number
- Triples of lines
- Parallelepiped
- Deforming parallelepiped
- Linking number of a triple

Amphicheiral and
Nonamphicheiral

Theorem. *Any two pairs of skew lines are isotopic.*

Proof. Move any pair of skew lines to a standard pair, in which the lines are perpendicular and their common perpendicular is of length 1.

Pair of lines

- Can lines be linked?
- Combing lines
- No parallel lines
- Equivalence of links made of skew lines
- **Pair of lines**
- Orientations and Semi-Orientations
- Linking number
- Triples of lines
- Parallelepiped
- Deforming parallelepiped
- Linking number of a triple

Amphicheiral and
Nonamphicheiral

Theorem. *Any two pairs of skew lines are isotopic.*

Proof. Move any pair of skew lines to a standard pair, in which the lines are perpendicular and their common perpendicular is of length 1.

To achieve this:

1. find the common perpendicular

Pair of lines

- Can lines be linked?
- Combing lines
- No parallel lines
- Equivalence of links made of skew lines
- **Pair of lines**
- Orientations and Semi-Orientations
- Linking number
- Triples of lines
- Parallelepiped
- Deforming parallelepiped
- Linking number of a triple

Amphicheiral and
Nonamphicheiral

Theorem. *Any two pairs of skew lines are isotopic.*

Proof. Move any pair of skew lines to a standard pair, in which the lines are perpendicular and their common perpendicular is of length 1.

To achieve this:

1. find the common perpendicular,
2. rotate one of the lines around it to make the lines perpendicular

Pair of lines

- Can lines be linked?
- Combing lines
- No parallel lines
- Equivalence of links made of skew lines
- **Pair of lines**
- Orientations and Semi-Orientations
- Linking number
- Triples of lines
- Parallelepiped
- Deforming parallelepiped
- Linking number of a triple

Amphicheiral and
Nonamphicheiral

Theorem. *Any two pairs of skew lines are isotopic.*

Proof. Move any pair of skew lines to a standard pair, in which the lines are perpendicular and their common perpendicular is of length 1.

To achieve this:

1. find the common perpendicular,
2. rotate one of the lines around it to make the lines perpendicular,
3. adjust the length of the common perpendicular.

Orientations and Semi-Orientations

- Can lines be linked?
- Combing lines
- No parallel lines
- Equivalence of links made of skew lines
- Pair of lines
- **Orientations and Semi-Orientations**
- Linking number
- Triples of lines
- Parallelepiped
- Deforming parallelepiped
- Linking number of a triple

Amphicheiral and
Nonamphicheiral

To *orient* a set of lines means to give a direction to each line in the set.

Orientations and Semi-Orientations

- Can lines be linked?
- Combing lines
- No parallel lines
- Equivalence of links made of skew lines
- Pair of lines
- **Orientations and Semi-Orientations**
- Linking number
- Triples of lines
- Parallelepiped
- Deforming parallelepiped
- Linking number of a triple

Amphicheiral and
Nonamphicheiral

To *orient* a set of lines means to give a direction to each line in the set. There are 2^n orientations of a set of n lines.

Orientations and Semi-Orientations

- Can lines be linked?
- Combing lines
- No parallel lines
- Equivalence of links made of skew lines
- Pair of lines
- **Orientations and Semi-Orientations**
- Linking number
- Triples of lines
- Parallelepiped
- Deforming parallelepiped
- Linking number of a triple

Amphicheiral and
Nonamphicheiral

To *orient* a set of lines means to give a direction to each line in the set. There are 2^n orientations of a set of n lines. A *semi-orientation* of a set of lines is a pair of opposite orientations.

Orientations and Semi-Orientations

- Can lines be linked?
- Combing lines
- No parallel lines
- Equivalence of links made of skew lines
- Pair of lines
- **Orientations and Semi-Orientations**
- Linking number
- Triples of lines
- Parallelepiped
- Deforming parallelepiped
- Linking number of a triple

Amphicheiral and Nonamphicheiral

To *orient* a set of lines means to give a direction to each line in the set. There are 2^n orientations of a set of n lines.

A *semi-orientation* of a set of lines is a pair of opposite orientations. A semi-orientation of a pair of lines:

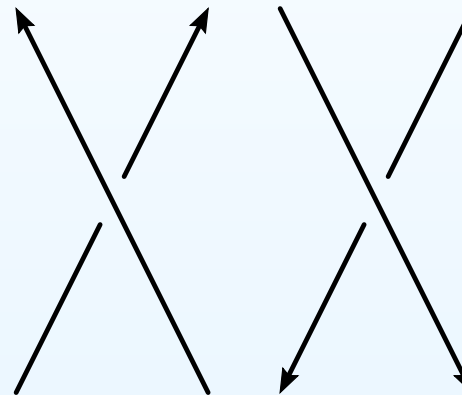

Linking number

- Can lines be linked?
- Combing lines
- No parallel lines
- Equivalence of links made of skew lines
- Pair of lines
- Orientations and Semi-Orientations
- **Linking number**
- Triples of lines
- Parallelepiped
- Deforming parallelepiped
- Linking number of a triple

Amphicheiral and
Nonamphicheiral

An oriented pair of lines has a characteristic which takes the value $+1$ or -1 .

Linking number

- Can lines be linked?
- Combing lines
- No parallel lines
- Equivalence of links made of skew lines
- Pair of lines
- Orientations and Semi-Orientations
- **Linking number**
- Triples of lines
- Parallelepiped
- Deforming parallelepiped
- Linking number of a triple

Amphicheiral and
Nonamphicheiral

An oriented pair of lines has a characteristic which takes the value $+1$ or -1 . It is called the *linking number*.

Linking number

- Can lines be linked?
- Combing lines
- No parallel lines
- Equivalence of links made of skew lines
- Pair of lines
- Orientations and Semi-Orientations
- **Linking number**
- Triples of lines
- Parallelepiped
- Deforming parallelepiped
- Linking number of a triple

Amphicheiral and
Nonamphicheiral

An oriented pair of lines has a characteristic which takes the value $+1$ or -1 . It is called the *linking number*.
The linking number is preserved under isotopies.

Linking number

- Can lines be linked?
- Combing lines
- No parallel lines
- Equivalence of links made of skew lines
- Pair of lines
- Orientations and Semi-Orientations
- **Linking number**
- Triples of lines
- Parallelepiped
- Deforming parallelepiped
- Linking number of a triple

Amphicheiral and
Nonamphicheiral

An oriented pair of lines has a characteristic which takes the value $+1$ or -1 . It is called the *linking number*.

The linking number is preserved under isotopies, and so if two oriented pairs of lines have different linking numbers, then they are not isotopic.

The linking number is $+1$ if the lines look like this:



Linking number

- Can lines be linked?
- Combing lines
- No parallel lines
- Equivalence of links made of skew lines
- Pair of lines
- Orientations and Semi-Orientations
- **Linking number**
- Triples of lines
- Parallelepiped
- Deforming parallelepiped
- Linking number of a triple

Amphicheiral and
Nonamphicheiral

An oriented pair of lines has a characteristic which takes the value $+1$ or -1 . It is called the *linking number*.

The linking number is preserved under isotopies, and so if two oriented pairs of lines have different linking numbers, then they are not isotopic.

The linking number is $+1$ if the lines look like this:

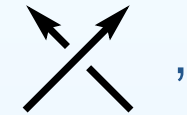

the linking number is -1 if the lines look like that:

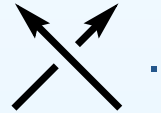

Linking number

- Can lines be linked?
- Combing lines
- No parallel lines
- Equivalence of links made of skew lines
- Pair of lines
- Orientations and Semi-Orientations
- **Linking number**
- Triples of lines
- Parallelepiped
- Deforming parallelepiped
- Linking number of a triple

Amphicheiral and Nonamphicheiral

An oriented pair of lines has a characteristic which takes the value $+1$ or -1 . It is called the *linking number*.

The linking number is preserved under isotopies, and so if two oriented pairs of lines have different linking numbers, then they are not isotopic.

The linking number is $+1$ if the lines look like this:

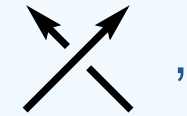

the linking number is -1 if the lines look like that:

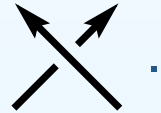

Exercise: Prove that the look does not depend on the **point of view** using only arguments of Elementary Geometry!

Linking number

- Can lines be linked?
- Combing lines
- No parallel lines
- Equivalence of links made of skew lines
- Pair of lines
- Orientations and Semi-Orientations
- **Linking number**
- Triples of lines
- Parallelepiped
- Deforming parallelepiped
- Linking number of a triple

Amphicheiral and Nonamphicheiral

An oriented pair of lines has a characteristic which takes the value $+1$ or -1 . It is called the *linking number*.

The linking number is preserved under isotopies, and so if two oriented pairs of lines have different linking numbers, then they are not isotopic.

The linking number is $+1$ if the lines look like this:

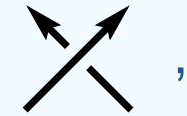

the linking number is -1 if the lines look like that:

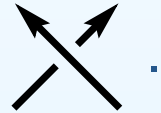

Changing the orientation of **one** of the lines of the pair changes the linking number.

Linking number

- Can lines be linked?
- Combing lines
- No parallel lines
- Equivalence of links made of skew lines
- Pair of lines
- Orientations and Semi-Orientations
- **Linking number**
- Triples of lines
- Parallelepiped
- Deforming parallelepiped
- Linking number of a triple

Amphicheiral and Nonamphicheiral

An oriented pair of lines has a characteristic which takes the value $+1$ or -1 . It is called the *linking number*.

The linking number is preserved under isotopies, and so if two oriented pairs of lines have different linking numbers, then they are not isotopic.

The linking number is $+1$ if the lines look like this:

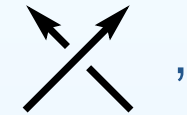

the linking number is -1 if the lines look like that:

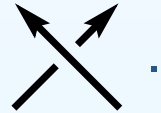

Changing the orientation of **one** of the lines of the pair **changes the linking number**. If the orientation of the pair reverses

Linking number

- Can lines be linked?
- Combing lines
- No parallel lines
- Equivalence of links made of skew lines
- Pair of lines
- Orientations and Semi-Orientations
- **Linking number**
- Triples of lines
- Parallelepiped
- Deforming parallelepiped
- Linking number of a triple

Amphicheiral and Nonamphicheiral

An oriented pair of lines has a characteristic which takes the value $+1$ or -1 . It is called the *linking number*.

The linking number is preserved under isotopies, and so if two oriented pairs of lines have different linking numbers, then they are not isotopic.

The linking number is $+1$ if the lines look like this:

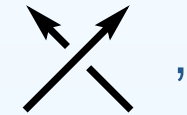

the linking number is -1 if the lines look like that:

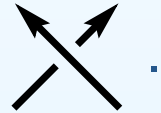

Changing the orientation of **one** of the lines of the pair **changes the linking number**. If the orientation of the pair reverses (i.e., the orientation reverses on both lines)

Linking number

- Can lines be linked?
- Combing lines
- No parallel lines
- Equivalence of links made of skew lines
- Pair of lines
- Orientations and Semi-Orientations
- **Linking number**
- Triples of lines
- Parallelepiped
- Deforming parallelepiped
- Linking number of a triple

Amphicheiral and Nonamphicheiral

An oriented pair of lines has a characteristic which takes the value $+1$ or -1 . It is called the *linking number*.

The linking number is preserved under isotopies, and so if two oriented pairs of lines have different linking numbers, then they are not isotopic.

The linking number is $+1$ if the lines look like this:

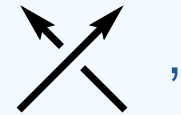

the linking number is -1 if the lines look like that:

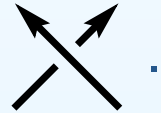

Changing the orientation of **one** of the lines of the pair **changes the linking number**. If the orientation of the pair reverses, then the linking number **does not change**.

Linking number

- Can lines be linked?
- Combing lines
- No parallel lines
- Equivalence of links made of skew lines
- Pair of lines
- Orientations and Semi-Orientations
- **Linking number**
- Triples of lines
- Parallelepiped
- Deforming parallelepiped
- Linking number of a triple

Amphicheiral and Nonamphicheiral

An oriented pair of lines has a characteristic which takes the value $+1$ or -1 . It is called the *linking number*.

The linking number is preserved under isotopies, and so if two oriented pairs of lines have different linking numbers, then they are not isotopic.

The linking number is $+1$ if the lines look like this:

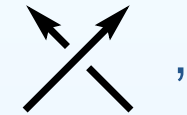

the linking number is -1 if the lines look like that:

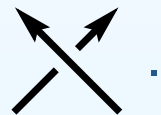

Changing the orientation of **one** of the lines of the pair **changes the linking number**. If the orientation of the pair reverses, then the linking number **does not change**.

Hence, *the linking number depends only on semi-orientation*.

Linking number

- Can lines be linked?
- Combing lines
- No parallel lines
- Equivalence of links made of skew lines
- Pair of lines
- Orientations and Semi-Orientations
- **Linking number**
- Triples of lines
- Parallelepiped
- Deforming parallelepiped
- Linking number of a triple

Amphicheiral and Nonamphicheiral

An oriented pair of lines has a characteristic which takes the value $+1$ or -1 . It is called the *linking number*.

The linking number is preserved under isotopies, and so if two oriented pairs of lines have different linking numbers, then they are not isotopic.

The linking number is $+1$ if the lines look like this:

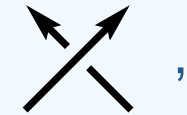

the linking number is -1 if the lines look like that:

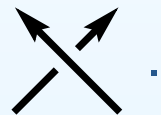

Changing the orientation of **one** of the lines of the pair changes the linking number. If the orientation of the pair reverses, then the linking number **does not change**.

Hence, *the linking number depends only on semi-orientation*.

Reflection in a mirror changes the linking number:



Linking number

- Can lines be linked?
- Combing lines
- No parallel lines
- Equivalence of links made of skew lines
- Pair of lines
- Orientations and Semi-Orientations
- **Linking number**
- Triples of lines
- Parallelepiped
- Deforming parallelepiped
- Linking number of a triple

Amphicheiral and Nonamphicheiral

An oriented pair of lines has a characteristic which takes the value $+1$ or -1 . It is called the *linking number*.

The linking number is preserved under isotopies, and so if two oriented pairs of lines have different linking numbers, then they are not isotopic.

The linking number is $+1$ if the lines look like this:  ,
 the linking number is -1 if the lines look like that: .

Changing the orientation of **one** of the lines of the pair changes the linking number. If the orientation of the pair reverses, then the linking number **does not change**.

Hence, *the linking number depends only on semi-orientation*.

Reflection in a mirror changes the linking number:

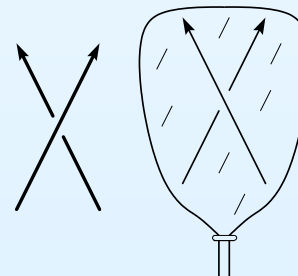

Triples of lines

- Can lines be linked?
- Combing lines
- No parallel lines
- Equivalence of links made of skew lines
- Pair of lines
- Orientations and Semi-Orientations
- Linking number
- Triples of lines
- Parallelepiped
- Deforming parallelepiped
- Linking number of a triple

Amphicheiral and
Nonamphicheiral

When we studied pairs of lines, an important role was played by the common perpendicular to the two skew lines.

Triples of lines

- Can lines be linked?
- Combing lines
- No parallel lines
- Equivalence of links made of skew lines
- Pair of lines
- Orientations and Semi-Orientations
- Linking number
- Triples of lines
- Parallelepiped
- Deforming parallelepiped
- Linking number of a triple

Amphicheiral and
Nonamphicheiral

When we studied pairs of lines, an important role was played by the common perpendicular to the two skew lines. It would be good to find something equally natural for a triple of skew lines.

Triples of lines

- Can lines be linked?
- Combing lines
- No parallel lines
- Equivalence of links made of skew lines
- Pair of lines
- Orientations and Semi-Orientations
- Linking number
- Triples of lines
- Parallelepiped
- Deforming parallelepiped
- Linking number of a triple

Amphicheiral and
Nonamphicheiral

When we studied pairs of lines, an important role was played by the common perpendicular to the two skew lines. It would be good to find something equally natural for a triple of skew lines. There are two objects that are capable of playing this role.

Triples of lines

- Can lines be linked?
- Combing lines
- No parallel lines
- Equivalence of links made of skew lines
- Pair of lines
- Orientations and Semi-Orientations
- Linking number
- Triples of lines
- Parallelepiped
- Deforming parallelepiped
- Linking number of a triple

Amphicheiral and
Nonamphicheiral

When we studied pairs of lines, an important role was played by the common perpendicular to the two skew lines. It would be good to find something equally natural for a triple of skew lines. There are two objects that are capable of playing this role. We shall discuss one of them now, and postpone consideration of the second one.

Triples of lines

- Can lines be linked?
- Combing lines
- No parallel lines
- Equivalence of links made of skew lines
- Pair of lines
- Orientations and Semi-Orientations
- Linking number
- Triples of lines
- Parallelepiped
- Deforming parallelepiped
- Linking number of a triple

Amphicheiral and
Nonamphicheiral

When we studied pairs of lines, an important role was played by the common perpendicular to the two skew lines. It would be good to find something equally natural for a triple of skew lines. There are two objects that are capable of playing this role. We shall discuss one of them now, and postpone consideration of the second one. Jumping ahead: the second object is a hyperboloid.

Triples of lines

- Can lines be linked?
- Combing lines
- No parallel lines
- Equivalence of links made of skew lines
- Pair of lines
- Orientations and Semi-Orientations
- Linking number
- Triples of lines
- Parallelepiped
- Deforming parallelepiped
- Linking number of a triple

Amphicheiral and
Nonamphicheiral

Consider an arbitrary triple of pairwise skew lines which do not lie in three parallel planes.

Triples of lines

- Can lines be linked?
- Combing lines
- No parallel lines
- Equivalence of links made of skew lines
- Pair of lines
- Orientations and Semi-Orientations
- Linking number
- Triples of lines
- Parallelepiped
- Deforming parallelepiped
- Linking number of a triple

Amphicheiral and
Nonamphicheiral

Consider an arbitrary triple of pairwise skew lines which do not lie in three parallel planes.

For each line draw two planes containing the line, each parallel to one of the other two lines.

Triples of lines

- Can lines be linked?
- Combing lines
- No parallel lines
- Equivalence of links made of skew lines
- Pair of lines
- Orientations and Semi-Orientations
- Linking number
- Triples of lines
- Parallelepiped
- Deforming parallelepiped
- Linking number of a triple

Amphicheiral and
Nonamphicheiral

Consider an arbitrary triple of pairwise skew lines which do not lie in three parallel planes.

For each line draw two planes containing the line, each parallel to one of the other two lines.

Overall six planes, i.e., three pairs of parallel planes.

Triples of lines

- Can lines be linked?
- Combing lines
- No parallel lines
- Equivalence of links made of skew lines
- Pair of lines
- Orientations and Semi-Orientations
- Linking number
- Triples of lines
- Parallelepiped
- Deforming parallelepiped
- Linking number of a triple

Amphicheiral and
Nonamphicheiral

Consider an arbitrary triple of pairwise skew lines which do not lie in three parallel planes.

For each line draw two planes containing the line, each parallel to one of the other two lines.

Overall six planes, i.e., three pairs of parallel planes.

These planes form a parallelepiped.

Triples of lines

- Can lines be linked?
- Combing lines
- No parallel lines
- Equivalence of links made of skew lines
- Pair of lines
- Orientations and Semi-Orientations
- Linking number
- Triples of lines
- Parallelepiped
- Deforming parallelepiped
- Linking number of a triple

Amphicheiral and Nonamphicheiral

Consider an arbitrary triple of pairwise skew lines which do not lie in three parallel planes.

For each line draw two planes containing the line, each parallel to one of the other two lines.

Overall six planes, i.e., three pairs of parallel planes.

These planes form a parallelepiped.

Our lines are the extensions of three of its skew edges:

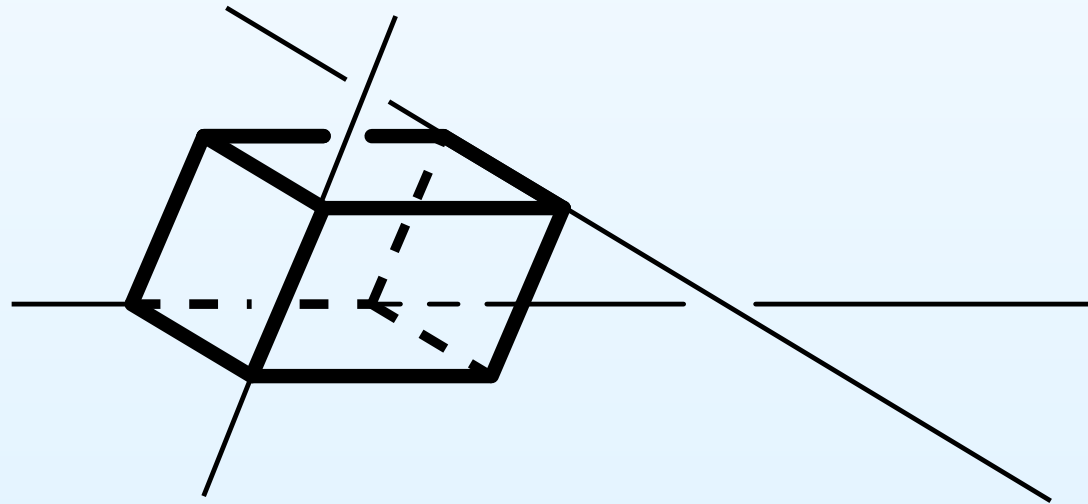

Parallelepiped

- Can lines be linked?
- Combing lines
- No parallel lines
- Equivalence of links made of skew lines
- Pair of lines
- Orientations and Semi-Orientations
- Linking number
- Triples of lines
- **Parallelepiped**
- Deforming parallelepiped
- Linking number of a triple

Amphicheiral and
Nonamphicheiral

Any three pair-wise skew lines which do not lie in three parallel planes are extensions of the edges of a parallelepiped.

Parallelepiped

- Can lines be linked?
- Combing lines
- No parallel lines
- Equivalence of links made of skew lines
- Pair of lines
- Orientations and Semi-Orientations
- Linking number
- Triples of lines
- **Parallelepiped**
- Deforming parallelepiped
- Linking number of a triple

Amphicheiral and
Nonamphicheiral

Any three pair-wise skew lines which do not lie in three parallel planes are extensions of the edges of a parallelepiped.

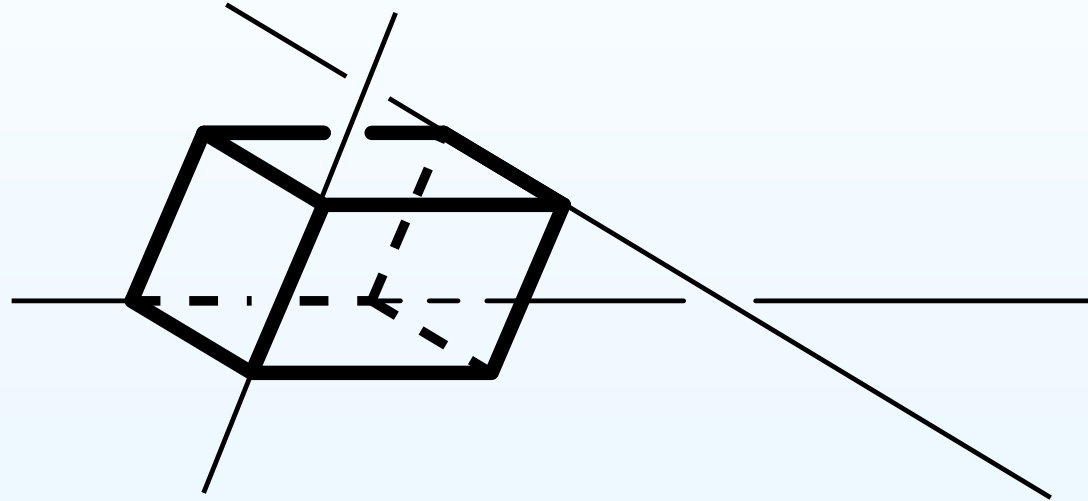

Parallelepiped

- Can lines be linked?
- Combing lines
- No parallel lines
- Equivalence of links made of skew lines
- Pair of lines
- Orientations and Semi-Orientations
- Linking number
- Triples of lines
- **Parallelepiped**
- Deforming parallelepiped
- Linking number of a triple

Amphicheiral and Nonamphicheiral

Any three pair-wise skew lines which do not lie in three parallel planes are extensions of the edges of a parallelepiped.

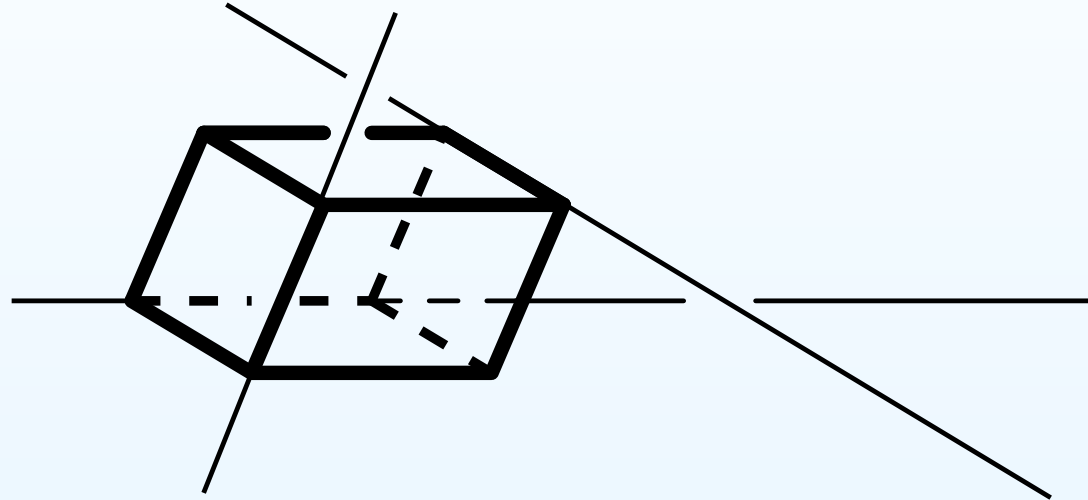

This parallelepiped is the first object which we associate to the triple of lines.

Parallelepiped

- Can lines be linked?
- Combing lines
- No parallel lines
- Equivalence of links made of skew lines
- Pair of lines
- Orientations and Semi-Orientations
- Linking number
- Triples of lines
- **Parallelepiped**
- Deforming parallelepiped
- Linking number of a triple

Amphicheiral and Nonamphicheiral

Any three pair-wise skew lines which do not lie in three parallel planes are extensions of the edges of a parallelepiped.

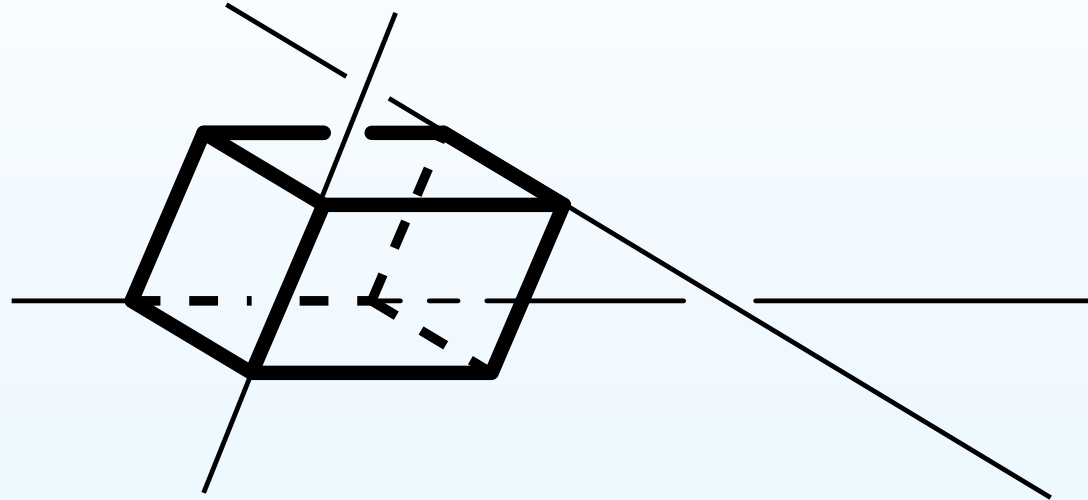

This parallelepiped is the first object which we associate to the triple of lines. **What is special about it?**

Parallelepiped

- Can lines be linked?
- Combing lines
- No parallel lines
- Equivalence of links made of skew lines
- Pair of lines
- Orientations and Semi-Orientations
- Linking number
- Triples of lines
- **Parallelepiped**
- Deforming parallelepiped
- Linking number of a triple

Amphicheiral and Nonamphicheiral

Any three pair-wise skew lines which do not lie in three parallel planes are extensions of the edges of a parallelepiped.

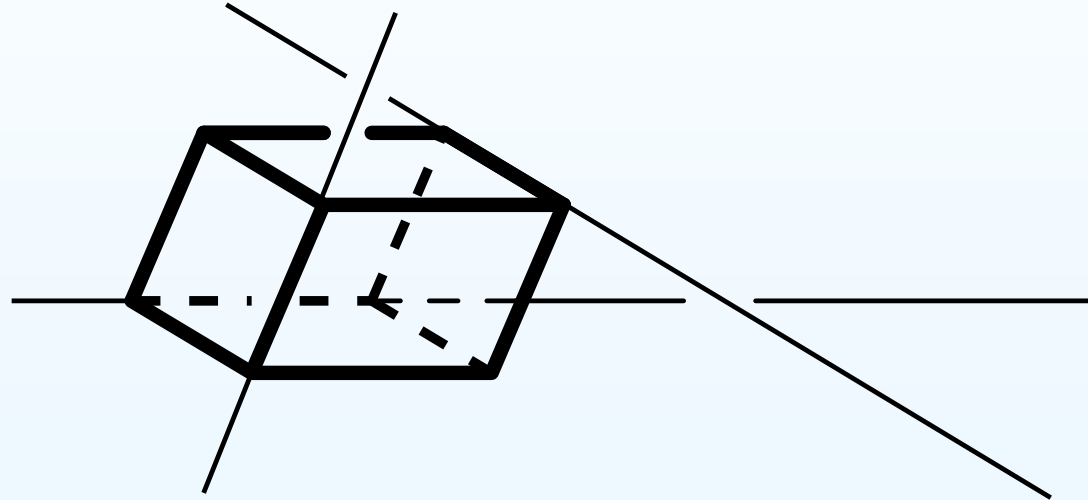

This parallelepiped is unique.

Parallelepiped

- Can lines be linked?
- Combing lines
- No parallel lines
- Equivalence of links made of skew lines
- Pair of lines
- Orientations and Semi-Orientations
- Linking number
- Triples of lines
- **Parallelepiped**
- Deforming parallelepiped
- Linking number of a triple

Amphicheiral and Nonamphicheiral

Any three pair-wise skew lines which do not lie in three parallel planes are extensions of the edges of a parallelepiped.

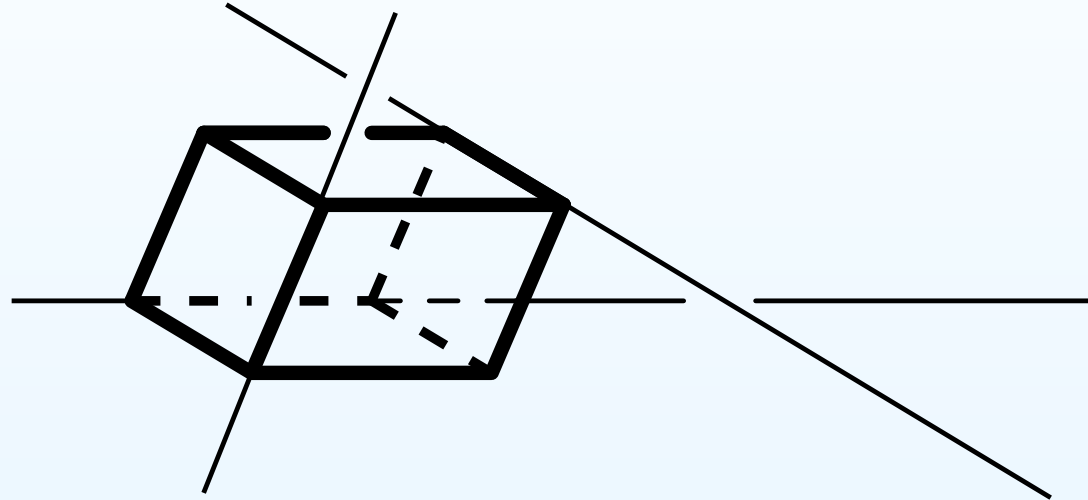

This parallelepiped is unique.

Indeed, there is a unique plane parallel to a given line that contains a second skew line.

Parallelepiped

- Can lines be linked?
- Combing lines
- No parallel lines
- Equivalence of links made of skew lines
- Pair of lines
- Orientations and Semi-Orientations
- Linking number
- Triples of lines
- **Parallelepiped**
- Deforming parallelepiped
- Linking number of a triple

Amphicheiral and Nonamphicheiral

Any three pair-wise skew lines which do not lie in three parallel planes are extensions of the edges of a parallelepiped.

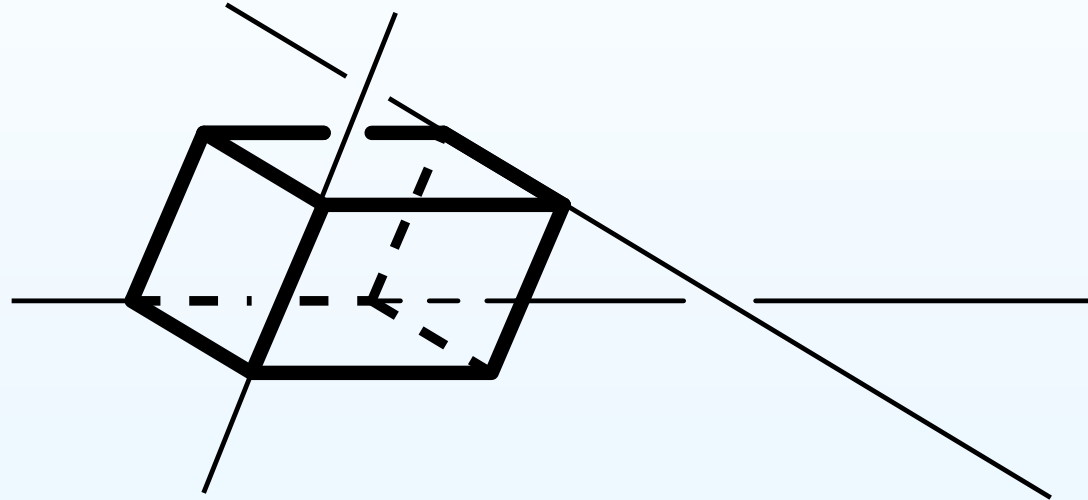

This parallelepiped is unique.

Indeed, there is a unique plane parallel to a given line that contains a second skew line.

Hence, the six planes are uniquely determined by the original triple of lines.

Deforming parallelipiped

- Can lines be linked?
- Combing lines
- No parallel lines
- Equivalence of links made of skew lines
- Pair of lines
- Orientations and Semi-Orientations
- Linking number
- Triples of lines
- Parallelipiped
- **Deforming parallelipiped**
- Linking number of a triple

Amphicheiral and
Nonamphicheiral

A parallelepiped is determined (up to isometry) by the lengths of its edges and the angles.

Deforming parallelepiped

- Can lines be linked?
- Combing lines
- No parallel lines
- Equivalence of links made of skew lines
- Pair of lines
- Orientations and Semi-Orientations
- Linking number
- Triples of lines
- Parallelepiped
- Deforming parallelepiped
- Linking number of a triple

Amphicheiral and
Nonamphicheiral

A parallelepiped is determined (up to isometry) by the lengths of its edges and the angles. By a continuous deformation, make all of the angles into right angles (obtaining a rectangular parallelepiped),

Deforming parallelipiped

- Can lines be linked?
- Combing lines
- No parallel lines
- Equivalence of links made of skew lines
- Pair of lines
- Orientations and Semi-Orientations
- Linking number
- Triples of lines
- Parallelipiped
- **Deforming parallelipiped**
- Linking number of a triple

Amphicheiral and
Nonamphicheiral

A parallelepiped is determined (up to isometry) by the lengths of its edges and the angles. By a continuous deformation, make all of the angles into right angles, then make the length of all edges equal to one (obtaining a cube).

Deforming parallelepiped

- Can lines be linked?
- Combing lines
- No parallel lines
- Equivalence of links made of skew lines
- Pair of lines
- Orientations and Semi-Orientations
- Linking number
- Triples of lines
- Parallelepiped
- **Deforming parallelepiped**
- Linking number of a triple

Amphicheiral and Nonamphicheiral

A parallelepiped is determined (up to isometry) by the lengths of its edges and the angles. By a continuous deformation, make all of the angles into right angles, then make the length of all edges equal to one

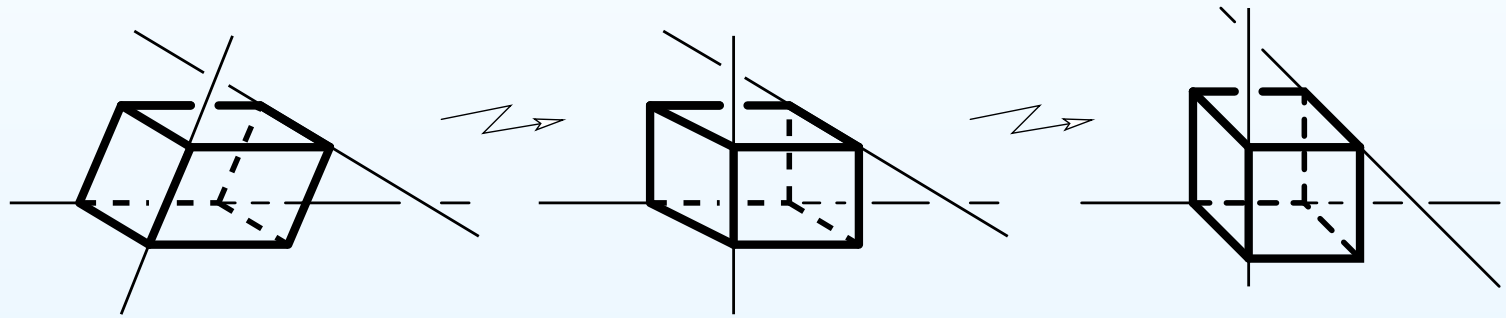

Deforming parallelepiped

- Can lines be linked?
- Combing lines
- No parallel lines
- Equivalence of links made of skew lines
- Pair of lines
- Orientations and Semi-Orientations
- Linking number
- Triples of lines
- Parallelepiped
- **Deforming parallelepiped**
- Linking number of a triple

Amphicheiral and
Nonamphicheiral

A parallelepiped is determined (up to isometry) by the lengths of its edges and the angles. By a continuous deformation, make all of the angles into right angles, then make the length of all edges equal to one

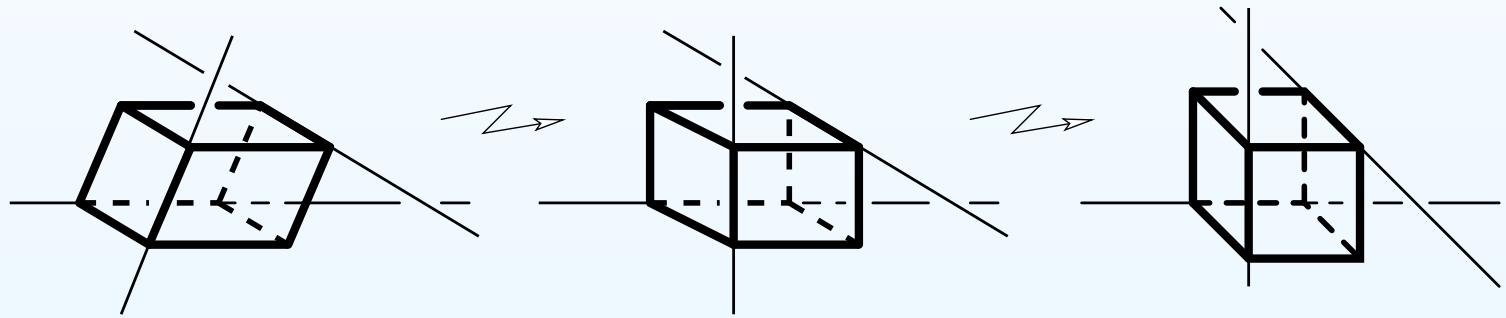

This induces an isotopy of the triple of lines.

Deforming parallelepiped

- Can lines be linked?
- Combing lines
- No parallel lines
- Equivalence of links made of skew lines
- Pair of lines
- Orientations and Semi-Orientations
- Linking number
- Triples of lines
- Parallelepiped
- Deforming parallelepiped
- Linking number of a triple

Amphicheiral and
Nonamphicheiral

A parallelepiped is determined (up to isometry) by the lengths of its edges and the angles. By a continuous deformation, make all of the angles into right angles, then make the length of all edges equal to one

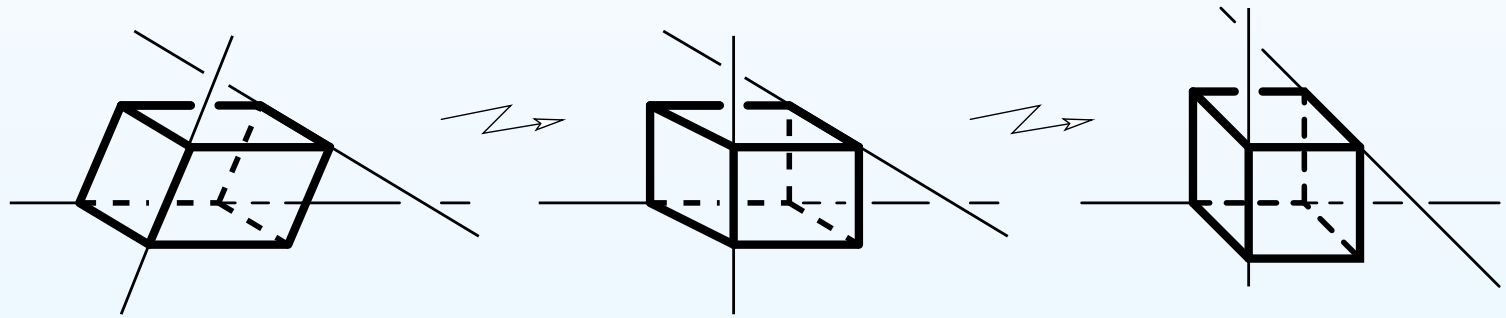

This induces an isotopy of the triple of lines.

The lines have been placed along pairwise skew edges of a unit cube.

Deforming parallelepiped

- Can lines be linked?
- Combing lines
- No parallel lines
- Equivalence of links made of skew lines
- Pair of lines
- Orientations and Semi-Orientations
- Linking number
- Triples of lines
- Parallelepiped
- **Deforming parallelepiped**
- Linking number of a triple

Amphicheiral and
Nonamphicheiral

A parallelepiped is determined (up to isometry) by the lengths of its edges and the angles. By a continuous deformation, make all of the angles into right angles, then make the length of all edges equal to one

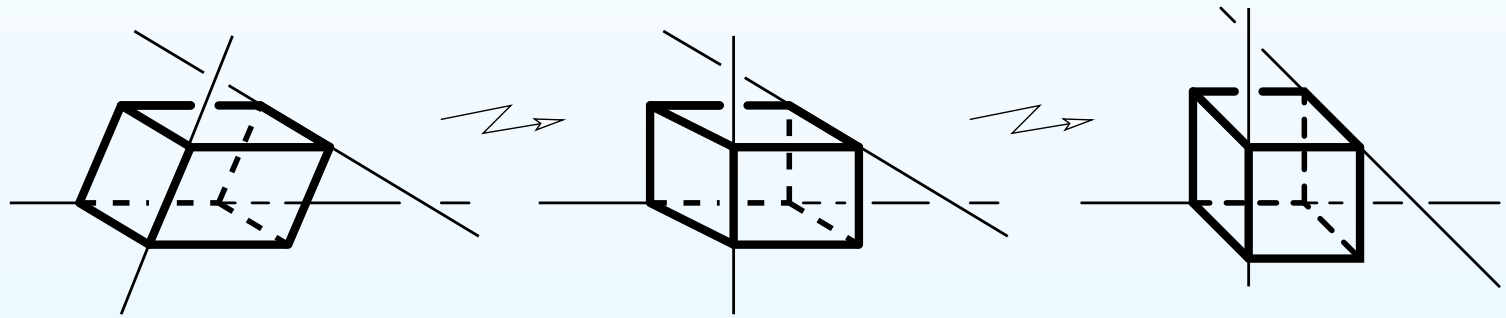

This induces an isotopy of the triple of lines.

The lines have been placed along pairwise skew edges of a unit cube. By a rotation of the cube, one can take any edge of the cube to any other edge.

Deforming parallelepiped

- Can lines be linked?
- Combing lines
- No parallel lines
- Equivalence of links made of skew lines
- Pair of lines
- Orientations and Semi-Orientations
- Linking number
- Triples of lines
- Parallelepiped
- **Deforming parallelepiped**
- Linking number of a triple

Amphicheiral and
Nonamphicheiral

A parallelepiped is determined (up to isometry) by the lengths of its edges and the angles. By a continuous deformation, make all of the angles into right angles, then make the length of all edges equal to one

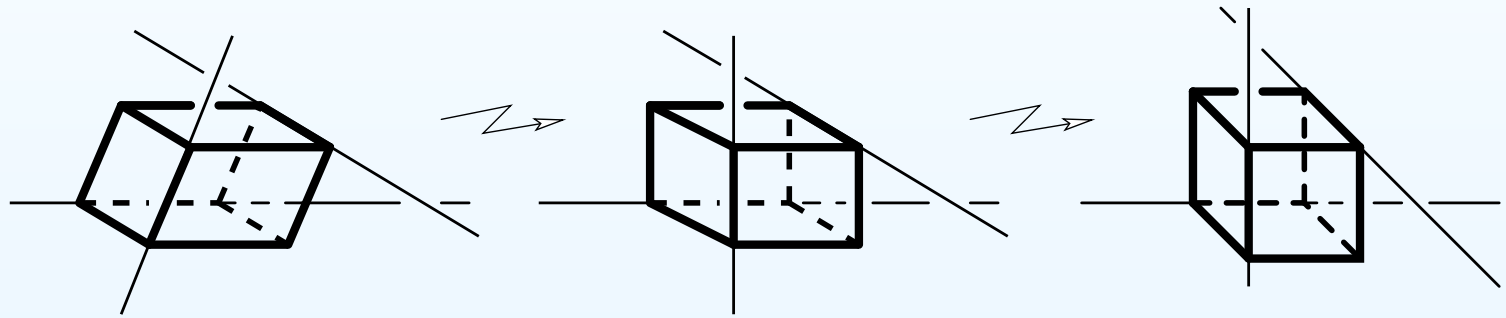

This induces an isotopy of the triple of lines.

The lines have been placed along pairwise skew edges of a unit cube. By a rotation of the cube, one can take any edge of the cube to any other edge.

This reduces the number of possible nonisotopic configurations to two.

Deforming parallelepiped

- Can lines be linked?
- Combing lines
- No parallel lines
- Equivalence of links made of skew lines
- Pair of lines
- Orientations and Semi-Orientations
- Linking number
- Triples of lines
- Parallelepiped
- **Deforming parallelepiped**
- Linking number of a triple

Amphicheiral and Nonamphicheiral

A parallelepiped is determined (up to isometry) by the lengths of its edges and the angles. By a continuous deformation, make all of the angles into right angles, then make the length of all edges equal to one

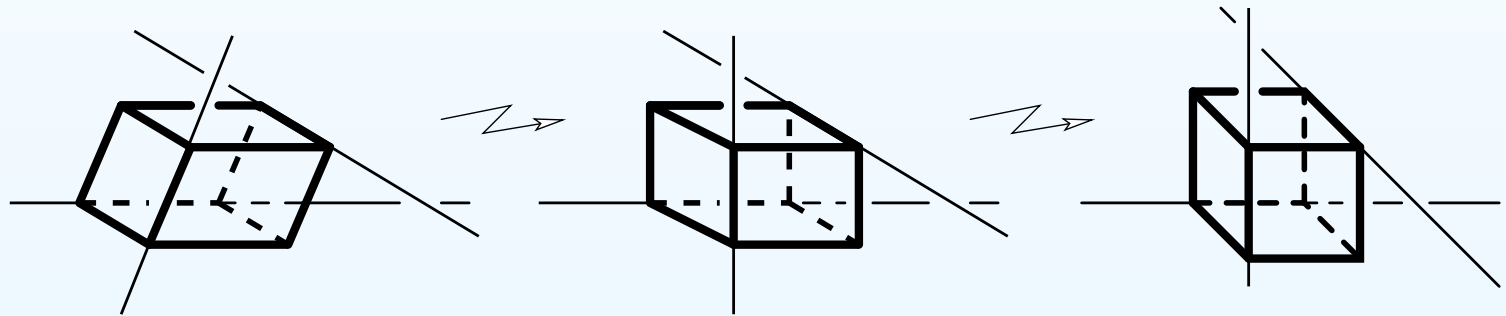

This induces an isotopy of the triple of lines.

The lines have been placed along pairwise skew edges of a unit cube. By a rotation of the cube, one can take any edge of the cube to any other edge.

This reduces the number of possible nonisotopic configurations to two.

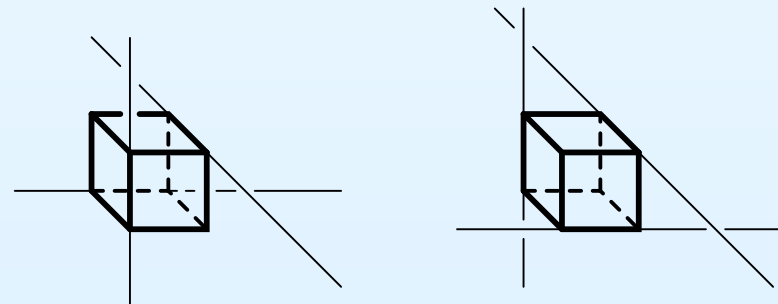

Linking number of a triple

- Can lines be linked?
- Combing lines
- No parallel lines
- Equivalence of links made of skew lines
- Pair of lines
- Orientations and Semi-Orientations
- Linking number
- Triples of lines
- Parallelepiped
- Deforming parallelepiped
- **Linking number of a triple**

Amphicheiral and
Nonamphicheiral

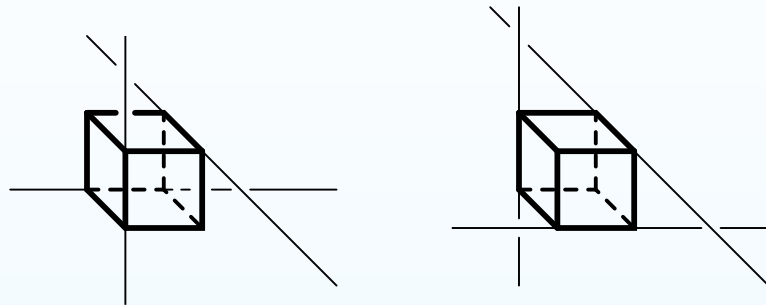

Linking number of a triple

- Can lines be linked?
- Combing lines
- No parallel lines
- Equivalence of links made of skew lines
- Pair of lines
- Orientations and Semi-Orientations
- Linking number
- Triples of lines
- Parallelepiped
- Deforming parallelepiped
- **Linking number of a triple**

Amphicheiral and
Nonamphicheiral

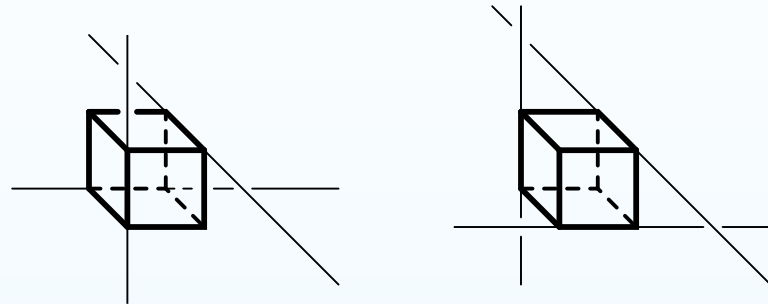

These two triples of lines are mirror images of each other.

Linking number of a triple

- Can lines be linked?
- Combing lines
- No parallel lines
- Equivalence of links made of skew lines
- Pair of lines
- Orientations and Semi-Orientations
- Linking number
- Triples of lines
- Parallelepiped
- Deforming parallelepiped
- Linking number of a triple

Amphicheiral and
Nonamphicheiral

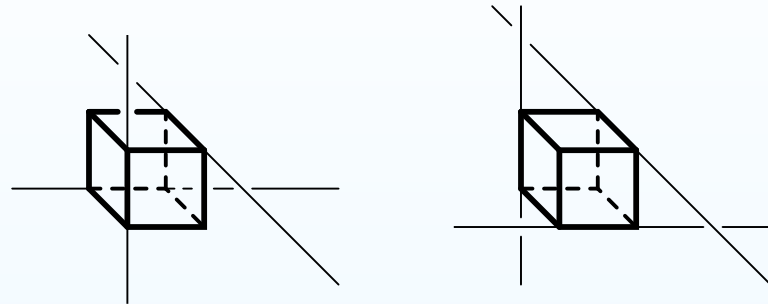

These two triples of lines are mirror images of each other.
They are **not isotopic**.

Linking number of a triple

- Can lines be linked?
- Combing lines
- No parallel lines
- Equivalence of links made of skew lines
- Pair of lines
- Orientations and Semi-Orientations
- Linking number
- Triples of lines
- Parallelepiped
- Deforming parallelepiped
- Linking number of a triple

Amphicheiral and
Nonamphicheiral

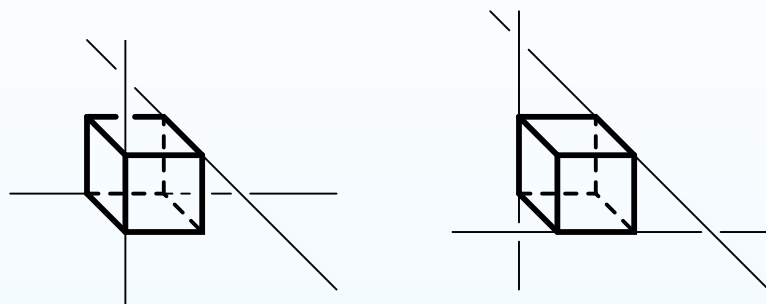

These two triples of lines are mirror images of each other. They are **not isotopic**. Triples of (nonoriented) lines have an invariant, also called the **linking number**

Linking number of a triple

- Can lines be linked?
- Combing lines
- No parallel lines
- Equivalence of links made of skew lines
- Pair of lines
- Orientations and Semi-Orientations
- Linking number
- Triples of lines
- Parallelepiped
- Deforming parallelepiped
- Linking number of a triple

Amphicheiral and
Nonamphicheiral

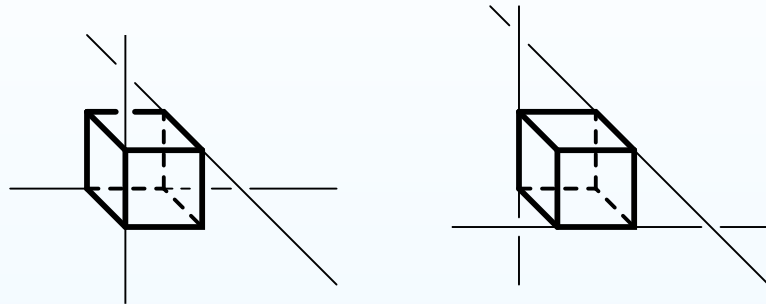

These two triples of lines are mirror images of each other. They are **not isotopic**. Triples of (nonoriented) lines have an invariant, also called the **linking number**, which takes the value $+1$ or -1

Linking number of a triple

- Can lines be linked?
- Combing lines
- No parallel lines
- Equivalence of links made of skew lines
- Pair of lines
- Orientations and Semi-Orientations
- Linking number
- Triples of lines
- Parallelepiped
- Deforming parallelepiped
- Linking number of a triple

Amphicheiral and Nonamphicheiral

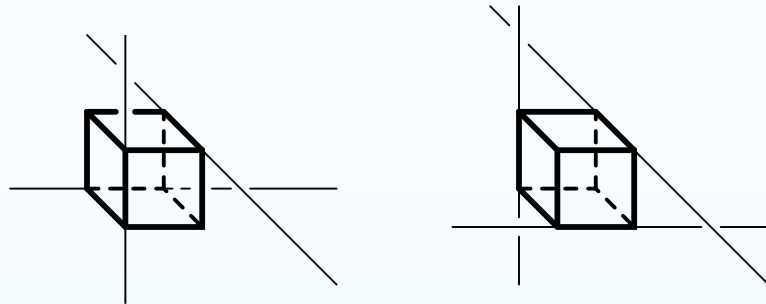

These two triples of lines are mirror images of each other. They are **not isotopic**. Triples of (nonoriented) lines have an invariant, also called the **linking number**, which takes the value $+1$ or -1 , is preserved under isotopies

Linking number of a triple

- Can lines be linked?
- Combing lines
- No parallel lines
- Equivalence of links made of skew lines
- Pair of lines
- Orientations and Semi-Orientations
- Linking number
- Triples of lines
- Parallelepiped
- Deforming parallelepiped
- Linking number of a triple

Amphicheiral and
Nonamphicheiral

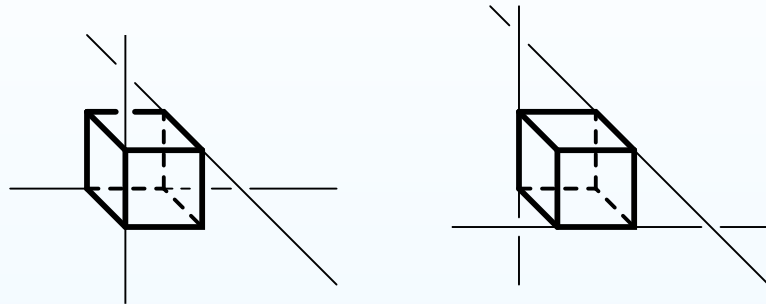

These two triples of lines are mirror images of each other. They are **not isotopic**. Triples of (nonoriented) lines have an invariant, also called the **linking number**, which takes the value $+1$ or -1 , is preserved under isotopies, and changes when one takes a mirror reflection of the triple of lines.

Linking number of a triple

- Can lines be linked?
- Combing lines
- No parallel lines
- Equivalence of links made of skew lines
- Pair of lines
- Orientations and Semi-Orientations
- Linking number
- Triples of lines
- Parallelepiped
- Deforming parallelepiped
- Linking number of a triple

Amphicheiral and
Nonamphicheiral

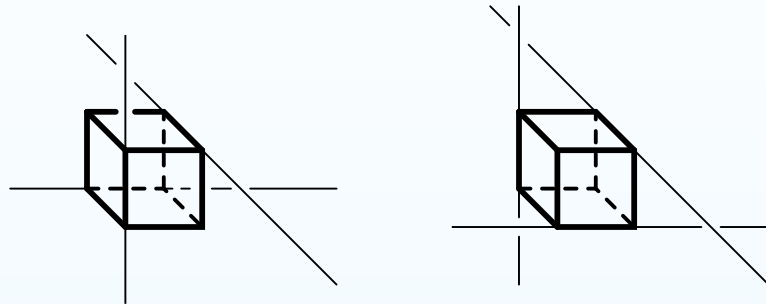

These two triples of lines are mirror images of each other. They are **not isotopic**. Triples of (nonoriented) lines have an invariant, also called the **linking number**, which takes the value $+1$ or -1 , is preserved under isotopies, and changes when one takes a mirror reflection of the triple of lines. To define it, **orient** the three lines **arbitrarily**.

Linking number of a triple

- Can lines be linked?
- Combing lines
- No parallel lines
- Equivalence of links made of skew lines
- Pair of lines
- Orientations and Semi-Orientations
- Linking number
- Triples of lines
- Parallelepiped
- Deforming parallelepiped
- Linking number of a triple

Amphicheiral and
Nonamphicheiral

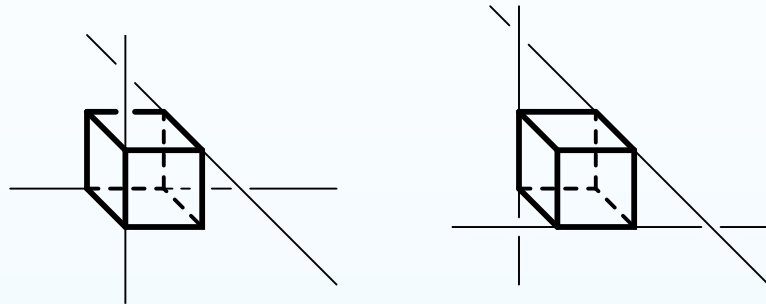

These two triples of lines are mirror images of each other. They are **not isotopic**. Triples of (nonoriented) lines have an invariant, also called the **linking number**, which takes the value $+1$ or -1 , is preserved under isotopies, and changes when one takes a mirror reflection of the triple of lines. To define it, **orient** the three lines **arbitrarily**. Each pair of lines in the triple has a linking number (equal to ± 1).

Linking number of a triple

- Can lines be linked?
- Combing lines
- No parallel lines
- Equivalence of links made of skew lines
- Pair of lines
- Orientations and Semi-Orientations
- Linking number
- Triples of lines
- Parallelepiped
- Deforming parallelepiped
- Linking number of a triple

Amphicheiral and
Nonamphicheiral

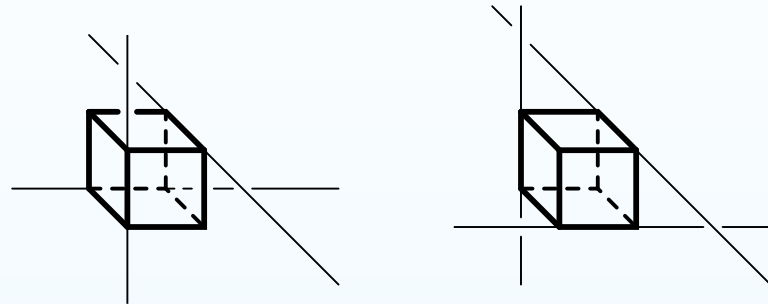

These two triples of lines are mirror images of each other. They are **not isotopic**. Triples of (nonoriented) lines have an invariant, also called the **linking number**, which takes the value $+1$ or -1 , is preserved under isotopies, and changes when one takes a mirror reflection of the triple of lines. To define it, **orient** the three lines **arbitrarily**. Each pair of lines in the triple has a linking number (equal to ± 1). Multiply all three linking numbers.

Linking number of a triple

- Can lines be linked?
- Combing lines
- No parallel lines
- Equivalence of links made of skew lines
- Pair of lines
- Orientations and Semi-Orientations
- Linking number
- Triples of lines
- Parallelepiped
- Deforming parallelepiped
- Linking number of a triple

Amphicheiral and Nonamphicheiral

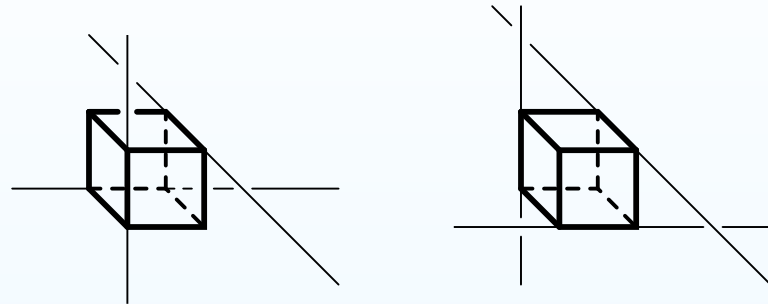

These two triples of lines are mirror images of each other. They are **not isotopic**. Triples of (nonoriented) lines have an invariant, also called the **linking number**, which takes the value $+1$ or -1 , is preserved under isotopies, and changes when one takes a mirror reflection of the triple of lines. To define it, **orient** the three lines **arbitrarily**. Each pair of lines in the triple has a linking number (equal to ± 1). Multiply all three linking numbers. The product is the **linking number of the triple**.

Linking number of a triple

- Can lines be linked?
- Combing lines
- No parallel lines
- Equivalence of links made of skew lines
- Pair of lines
- Orientations and Semi-Orientations
- Linking number
- Triples of lines
- Parallelepiped
- Deforming parallelepiped
- Linking number of a triple

Amphicheiral and Nonamphicheiral

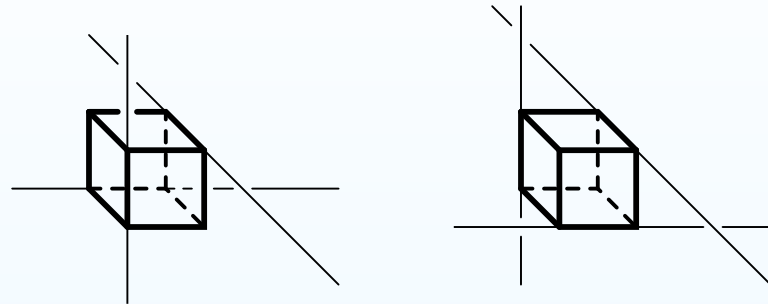

These two triples of lines are mirror images of each other. They are **not isotopic**. Triples of (nonoriented) lines have an invariant, also called the **linking number**, which takes the value $+1$ or -1 , is preserved under isotopies, and changes when one takes a mirror reflection of the triple of lines. To define it, **orient** the three lines **arbitrarily**. Each pair of lines in the triple has a linking number (equal to ± 1). Multiply all three linking numbers. The product is the **linking number of the triple**. This number does not depend on the **orientation** of the lines

Linking number of a triple

- Can lines be linked?
- Combing lines
- No parallel lines
- Equivalence of links made of skew lines
- Pair of lines
- Orientations and Semi-Orientations
- Linking number
- Triples of lines
- Parallelepiped
- Deforming parallelepiped
- Linking number of a triple

Amphicheiral and Nonamphicheiral

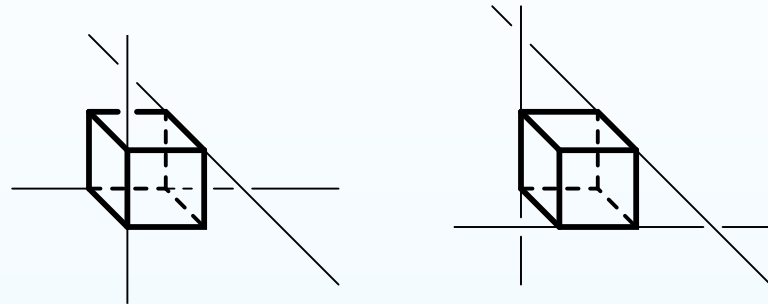

These two triples of lines are mirror images of each other. They are **not isotopic**. Triples of (nonoriented) lines have an invariant, also called the **linking number**, which takes the value $+1$ or -1 , is preserved under isotopies, and changes when one takes a mirror reflection of the triple of lines. To define it, **orient** the three lines **arbitrarily**. Each pair of lines in the triple has a linking number (equal to ± 1). Multiply all three linking numbers. The product is the **linking number of the triple**. This number does not depend on the **orientation** of the lines, since if we reverse the orientation of any line, two factors change the sign.

- Can lines be linked?
- Combing lines
- No parallel lines
- Equivalence of links made of skew lines
- Pair of lines
- Orientations and Semi-Orientations
- Linking number
- Triples of lines
- Parallelepiped
- Deforming parallelepiped
- Linking number of a triple

Amphicheiral and Nonamphicheiral

- Amphicheirality problems
- Nonamphicheiral examples
- Amphicheiral examples
- Amphicheiral examples
- Four lines
- Five lines

Amphicheiral and Nonamphicheiral

Amphicheirality problems

A triple of skew lines is never isotopic to its mirror image.

- Can lines be linked?
- Combing lines
- No parallel lines
- Equivalence of links made of skew lines
- Pair of lines
- Orientations and Semi-Orientations
- Linking number
- Triples of lines
- Parallelepiped
- Deforming parallelepiped
- Linking number of a triple

Amphicheiral and Nonamphicheiral

- **Amphicheirality problems**
- Nonamphicheiral examples
- Amphicheiral examples
- Amphicheiral examples
- Four lines
- Five lines

Amphicheirality problems

A triple of skew lines is never isotopic to its mirror image, while a pair of lines is isotopic to its mirror image.

- Can lines be linked?
- Combing lines
- No parallel lines
- Equivalence of links made of skew lines
- Pair of lines
- Orientations and Semi-Orientations
- Linking number
- Triples of lines
- Parallelepiped
- Deforming parallelepiped
- Linking number of a triple

Amphicheiral and Nonamphicheiral

- **Amphicheirality problems**
- Nonamphicheiral examples
- Amphicheiral examples
- Amphicheiral examples
- Four lines
- Five lines

Amphicheirality problems

- Can lines be linked?
- Combing lines
- No parallel lines
- Equivalence of links made of skew lines
- Pair of lines
- Orientations and Semi-Orientations
- Linking number
- Triples of lines
- Parallelepiped
- Deforming parallelepiped
- Linking number of a triple

Amphicheiral and Nonamphicheiral

- **Amphicheirality problems**
- Nonamphicheiral examples
- Amphicheiral examples
- Amphicheiral examples
- Four lines
- Five lines

A triple of skew lines is never isotopic to its mirror image, while a pair of lines is isotopic to its mirror image.

A set of pairwise skew lines is *amphicheiral* if it is isotopic to its mirror image.

Amphicheirality problems

- Can lines be linked?
- Combing lines
- No parallel lines
- Equivalence of links made of skew lines
- Pair of lines
- Orientations and Semi-Orientations
- Linking number
- Triples of lines
- Parallelepiped
- Deforming parallelepiped
- Linking number of a triple

Amphicheiral and Nonamphicheiral

- **Amphicheirality problems**
- Nonamphicheiral examples
- Amphicheiral examples
- Amphicheiral examples
- Four lines
- Five lines

A triple of skew lines is never isotopic to its mirror image, while a pair of lines is isotopic to its mirror image.

A set of pairwise skew lines is *amphicheiral* if it is isotopic to its mirror image.

Thus, a triple is nonamphicheiral, and a pair is amphicheiral.

Amphicheirality problems

- Can lines be linked?
- Combing lines
- No parallel lines
- Equivalence of links made of skew lines
- Pair of lines
- Orientations and Semi-Orientations
- Linking number
- Triples of lines
- Parallelepiped
- Deforming parallelepiped
- Linking number of a triple

Amphicheiral and Nonamphicheiral

- **Amphicheirality problems**
- Nonamphicheiral examples
- Amphicheiral examples
- Amphicheiral examples
- Four lines
- Five lines

A triple of skew lines is never isotopic to its mirror image, while a pair of lines is isotopic to its mirror image.

A set of pairwise skew lines is *amphicheiral* if it is isotopic to its mirror image.

Thus, a triple is nonamphicheiral, and a pair is amphicheiral.

The following questions arise:

Amphicheirality problems

- Can lines be linked?
- Combing lines
- No parallel lines
- Equivalence of links made of skew lines
- Pair of lines
- Orientations and Semi-Orientations
- Linking number
- Triples of lines
- Parallelepiped
- Deforming parallelepiped
- Linking number of a triple

Amphicheiral and Nonamphicheiral

- **Amphicheirality problems**
- Nonamphicheiral examples
- Amphicheiral examples
- Amphicheiral examples
- Four lines
- Five lines

A triple of skew lines is never isotopic to its mirror image, while a pair of lines is isotopic to its mirror image.

A set of pairwise skew lines is *amphicheiral* if it is isotopic to its mirror image.

Thus, a triple is nonamphicheiral, and a pair is amphicheiral.

The following questions arise:

1. For what p is any link of p lines nonamphicheiral?

Amphicheirality problems

- Can lines be linked?
- Combing lines
- No parallel lines
- Equivalence of links made of skew lines
- Pair of lines
- Orientations and Semi-Orientations
- Linking number
- Triples of lines
- Parallelepiped
- Deforming parallelepiped
- Linking number of a triple

Amphicheiral and Nonamphicheiral

- **Amphicheirality problems**
- Nonamphicheiral examples
- Amphicheiral examples
- Amphicheiral examples
- Four lines
- Five lines

A triple of skew lines is never isotopic to its mirror image, while a pair of lines is isotopic to its mirror image.

A set of pairwise skew lines is *amphicheiral* if it is isotopic to its mirror image.

Thus, a triple is nonamphicheiral, and a pair is amphicheiral.

The following questions arise:

1. For what p is any link of p lines nonamphicheiral?
2. For what p is any link of p lines amphicheiral?

Amphicheirality problems

- Can lines be linked?
- Combing lines
- No parallel lines
- Equivalence of links made of skew lines
- Pair of lines
- Orientations and Semi-Orientations
- Linking number
- Triples of lines
- Parallelepiped
- Deforming parallelepiped
- Linking number of a triple

Amphicheiral and Nonamphicheiral

- **Amphicheirality problems**
- Nonamphicheiral examples
- Amphicheiral examples
- Amphicheiral examples
- Four lines
- Five lines

A triple of skew lines is never isotopic to its mirror image, while a pair of lines is isotopic to its mirror image.

A set of pairwise skew lines is *amphicheiral* if it is isotopic to its mirror image.

Thus, a triple is nonamphicheiral, and a pair is amphicheiral.

The following questions arise:

1. For what p is any link of p lines nonamphicheiral?
2. For what p is any link of p lines amphicheiral?
3. For what p does there exist a nonamphicheiral link of p lines?

Amphicheirality problems

- Can lines be linked?
- Combing lines
- No parallel lines
- Equivalence of links made of skew lines
- Pair of lines
- Orientations and Semi-Orientations
- Linking number
- Triples of lines
- Parallelepiped
- Deforming parallelepiped
- Linking number of a triple

Amphicheiral and Nonamphicheiral

- **Amphicheirality problems**
- Nonamphicheiral examples
- Amphicheiral examples
- Amphicheiral examples
- Four lines
- Five lines

A triple of skew lines is never isotopic to its mirror image, while a pair of lines is isotopic to its mirror image.

A set of pairwise skew lines is *amphicheiral* if it is isotopic to its mirror image.

Thus, a triple is nonamphicheiral, and a pair is amphicheiral.

The following questions arise:

1. For what p is any link of p lines nonamphicheiral?
2. For what p is any link of p lines amphicheiral?
3. For what p does there exist a nonamphicheiral link of p lines?
4. For what p does there exist an amphicheiral link of p lines?

Amphicheirality problems

- Can lines be linked?
- Combing lines
- No parallel lines
- Equivalence of links made of skew lines
- Pair of lines
- Orientations and Semi-Orientations
- Linking number
- Triples of lines
- Parallelepiped
- Deforming parallelepiped
- Linking number of a triple

Amphicheiral and Nonamphicheiral

- **Amphicheirality problems**
- Nonamphicheiral examples
- Amphicheiral examples
- Amphicheiral examples
- Four lines
- Five lines

A triple of skew lines is never isotopic to its mirror image, while a pair of lines is isotopic to its mirror image.

A set of pairwise skew lines is *amphicheiral* if it is isotopic to its mirror image.

Thus, a triple is nonamphicheiral, and a pair is amphicheiral.

The following questions arise:

1. For what p is any link of p lines nonamphicheiral?
2. For what p is any link of p lines amphicheiral?
3. For what p does there exist a nonamphicheiral link of p lines?
4. For what p does there exist an amphicheiral link of p lines?

Theorem. If $p \equiv 3 \pmod{4}$, then every link of p lines is nonamphicheiral.

Amphicheirality problems

- Can lines be linked?
- Combing lines
- No parallel lines
- Equivalence of links made of skew lines
- Pair of lines
- Orientations and Semi-Orientations
- Linking number
- Triples of lines
- Parallelepiped
- Deforming parallelepiped
- Linking number of a triple

Amphicheiral and Nonamphicheiral

- **Amphicheirality problems**
- Nonamphicheiral examples
- Amphicheiral examples
- Amphicheiral examples
- Four lines
- Five lines

A triple of skew lines is never isotopic to its mirror image, while a pair of lines is isotopic to its mirror image.

A set of pairwise skew lines is *amphicheiral* if it is isotopic to its mirror image.

Thus, a triple is nonamphicheiral, and a pair is amphicheiral.

The following questions arise:

1. For what p is any link of p lines nonamphicheiral?
2. For what p is any link of p lines amphicheiral?
3. For what p does there exist a nonamphicheiral link of p lines?
4. For what p does there exist an amphicheiral link of p lines?

Theorem. If $p \equiv 3 \pmod{4}$, then every link of p lines is nonamphicheiral.

Proof. The number of triples in a link of p lines is equal to $p(p-1)(p-2)/6$

Amphicheirality problems

- Can lines be linked?
- Combing lines
- No parallel lines
- Equivalence of links made of skew lines
- Pair of lines
- Orientations and Semi-Orientations
- Linking number
- Triples of lines
- Parallelepiped
- Deforming parallelepiped
- Linking number of a triple

Amphicheiral and Nonamphicheiral

- **Amphicheirality problems**
- Nonamphicheiral examples
- Amphicheiral examples
- Amphicheiral examples
- Four lines
- Five lines

A triple of skew lines is never isotopic to its mirror image, while a pair of lines is isotopic to its mirror image.

A set of pairwise skew lines is *amphicheiral* if it is isotopic to its mirror image.

Thus, a triple is nonamphicheiral, and a pair is amphicheiral.

The following questions arise:

1. For what p is any link of p lines nonamphicheiral?
2. For what p is any link of p lines amphicheiral?
3. For what p does there exist a nonamphicheiral link of p lines?
4. For what p does there exist an amphicheiral link of p lines?

Theorem. If $p \equiv 3 \pmod{4}$, then every link of p lines is nonamphicheiral.

Proof. The number of triples in a link of p lines is equal to $p(p-1)(p-2)/6$, and this is odd iff $p \equiv 3 \pmod{4}$. ●

Nonamphicheiral examples

- Can lines be linked?
- Combing lines
- No parallel lines
- Equivalence of links made of skew lines
- Pair of lines
- Orientations and Semi-Orientations
- Linking number
- Triples of lines
- Parallelepiped
- Deforming parallelepiped
- Linking number of a triple

Amphicheiral and Nonamphicheiral

- Amphicheirality problems
- **Nonamphicheiral examples**
- Amphicheiral examples
- Amphicheiral examples
- Four lines
- Five lines

Theorem 1 gives an affirmative answer to the first of the four questions above for $p \equiv 3 \pmod{4}$.

Nonamphicheiral examples

- Can lines be linked?
- Combing lines
- No parallel lines
- Equivalence of links made of skew lines
- Pair of lines
- Orientations and Semi-Orientations
- Linking number
- Triples of lines
- Parallelepiped
- Deforming parallelepiped
- Linking number of a triple

Amphicheiral and Nonamphicheiral

- Amphicheirality problems
- **Nonamphicheiral examples**
- Amphicheiral examples
- Amphicheiral examples
- Four lines
- Five lines

Theorem 1 gives an affirmative answer to the first of the four questions above for $p \equiv 3 \pmod{4}$.

The second question has a negative answer for any $p \geq 3$: one can construct a nonamphicheiral link of p lines.

Nonamphicheiral examples

- Can lines be linked?
- Combing lines
- No parallel lines
- Equivalence of links made of skew lines
- Pair of lines
- Orientations and Semi-Orientations
- Linking number
- Triples of lines
- Parallelepiped
- Deforming parallelepiped
- Linking number of a triple

Amphicheiral and Nonamphicheiral

- Amphicheirality problems
- **Nonamphicheiral examples**
- Amphicheiral examples
- Amphicheiral examples
- Four lines
- Five lines

Theorem 1 gives an affirmative answer to the first of the four questions above for $p \equiv 3 \pmod{4}$.

The second question has a negative answer for any $p \geq 3$: one can construct a nonamphicheiral link of p lines.

This also answers question 3.

Nonamphicheiral examples

- Can lines be linked?
- Combing lines
- No parallel lines
- Equivalence of links made of skew lines
- Pair of lines
- Orientations and Semi-Orientations
- Linking number
- Triples of lines
- Parallelepiped
- Deforming parallelepiped
- Linking number of a triple

Amphicheiral and Nonamphicheiral

- Amphicheirality problems
- **Nonamphicheiral examples**
- Amphicheiral examples
- Amphicheiral examples
- Four lines
- Five lines

Theorem 1 gives an affirmative answer to the first of the four questions above for $p \equiv 3 \pmod{4}$.

The second question has a negative answer for any $p \geq 3$: one can construct a nonamphicheiral link of p lines.

This also answers question 3.

The simplest nonamphicheiral links for $p = 4, 5$, and 6 :

Nonamphicheiral examples

- Can lines be linked?
- Combing lines
- No parallel lines
- Equivalence of links made of skew lines
- Pair of lines
- Orientations and Semi-Orientations
- Linking number
- Triples of lines
- Parallelepiped
- Deforming parallelepiped
- Linking number of a triple

Amphicheiral and Nonamphicheiral

- Amphicheirality problems
- **Nonamphicheiral examples**
- Amphicheiral examples
- Amphicheiral examples
- Four lines
- Five lines

Theorem 1 gives an affirmative answer to the first of the four questions above for $p \equiv 3 \pmod{4}$.

The second question has a negative answer for any $p \geq 3$: one can construct a nonamphicheiral link of p lines.

This also answers question 3.

The simplest nonamphicheiral links for $p = 4, 5$, and 6 :

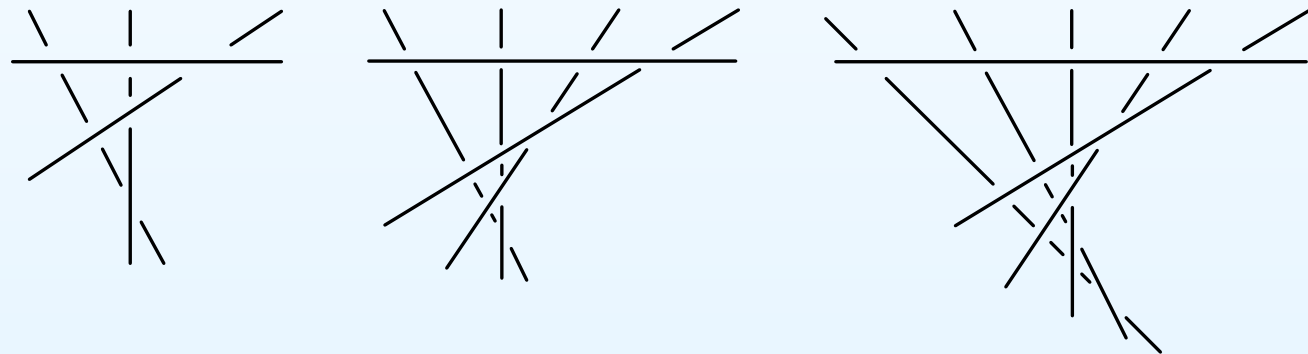

Nonamphicheiral examples

- Can lines be linked?
- Combing lines
- No parallel lines
- Equivalence of links made of skew lines
- Pair of lines
- Orientations and Semi-Orientations
- Linking number
- Triples of lines
- Parallelepiped
- Deforming parallelepiped
- Linking number of a triple

Amphicheiral and Nonamphicheiral

- Amphicheirality problems
- **Nonamphicheiral examples**
- Amphicheiral examples
- Amphicheiral examples
- Four lines
- Five lines

Theorem 1 gives an affirmative answer to the first of the four questions above for $p \equiv 3 \pmod{4}$.

The second question has a negative answer for any $p \geq 3$: one can construct a nonamphicheiral link of p lines.

This also answers question 3.

The simplest nonamphicheiral links for $p = 4, 5$, and 6 :

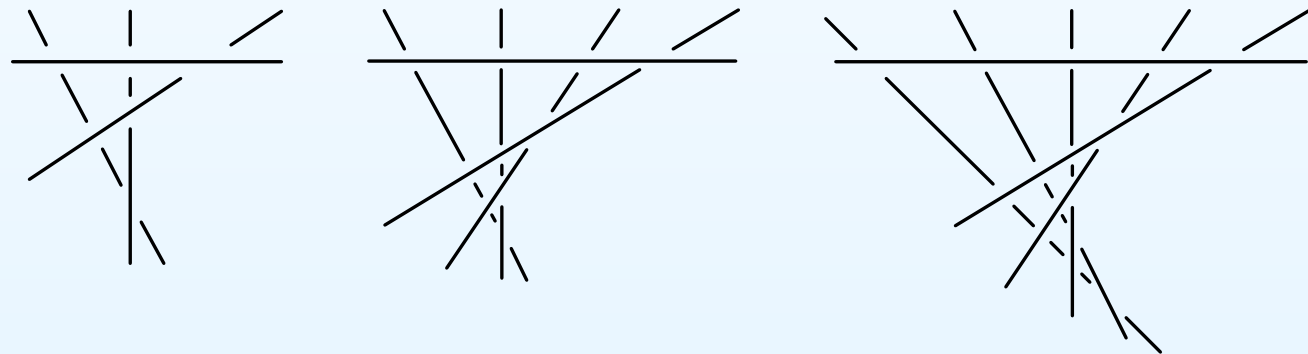

The links are nonamphicheiral since all of the triples of lines in them have the same linking number.

Amphicheiral examples

- Can lines be linked?
- Combing lines
- No parallel lines
- Equivalence of links made of skew lines
- Pair of lines
- Orientations and Semi-Orientations
- Linking number
- Triples of lines
- Parallelepiped
- Deforming parallelepiped
- Linking number of a triple

Amphicheiral and Nonamphicheiral

- Amphicheirality problems
- Nonamphicheiral examples
- **Amphicheiral examples**
- Amphicheiral examples
- Four lines
- Five lines

To answer Question 4, construct amphicheiral links of p lines when $p \not\equiv 3 \pmod{4}$.

Amphicheiral examples

- Can lines be linked?
- Combing lines
- No parallel lines
- Equivalence of links made of skew lines
- Pair of lines
- Orientations and Semi-Orientations
- Linking number
- Triples of lines
- Parallelepiped
- Deforming parallelepiped
- Linking number of a triple

Amphicheiral and Nonamphicheiral

- Amphicheirality problems
- Nonamphicheiral examples
- **Amphicheiral examples**
- Amphicheiral examples
- Four lines
- Five lines

To answer Question 4, construct amphicheiral links of p lines when $p \not\equiv 3 \pmod{4}$. The simplest example ($p = 4$):

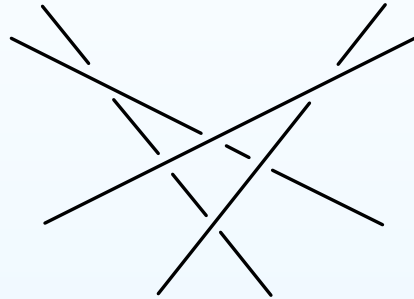

Amphicheiral examples

- Can lines be linked?
- Combing lines
- No parallel lines
- Equivalence of links made of skew lines
- Pair of lines
- Orientations and Semi-Orientations
- Linking number
- Triples of lines
- Parallelepiped
- Deforming parallelepiped
- Linking number of a triple

Amphicheiral and Nonamphicheiral

- Amphicheirality problems
- Nonamphicheiral examples
- **Amphicheiral examples**
- Amphicheiral examples
- Four lines
- Five lines

To answer Question 4, construct amphicheiral links of p lines when $p \not\equiv 3 \pmod{4}$. The simplest example ($p = 4$):

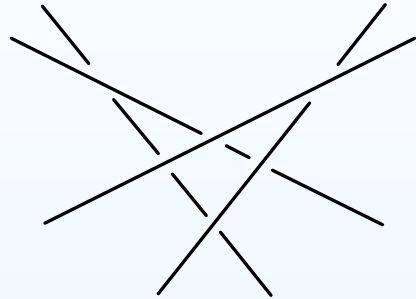

To prove amphicheirality of the link, move the upper two lines in such a way that the part of its projection which contains all of the intersections (in the projection) passes

over and above the projection of the other two lines:

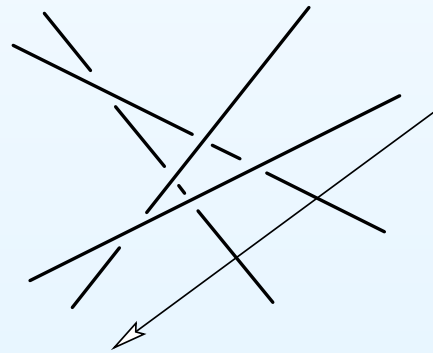

Amphicheiral examples

- Can lines be linked?
- Combing lines
- No parallel lines
- Equivalence of links made of skew lines
- Pair of lines
- Orientations and Semi-Orientations
- Linking number
- Triples of lines
- Parallelepiped
- Deforming parallelepiped
- Linking number of a triple

Amphicheiral and Nonamphicheiral

- Amphicheirality problems
- Nonamphicheiral examples
- **Amphicheiral examples**
- Amphicheiral examples
- Four lines
- Five lines

To answer Question 4, construct amphicheiral links of p lines when $p \not\equiv 3 \pmod{4}$. The simplest example ($p = 4$):

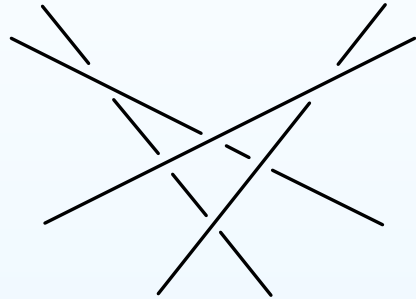

over and above the projection of the other two lines:

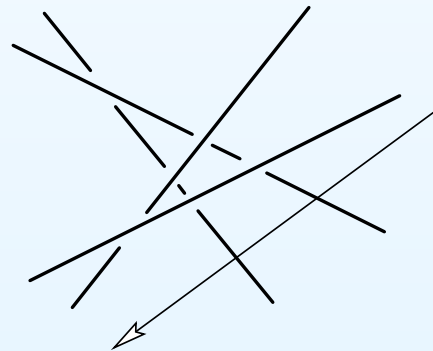

To prove amphicheirality of the link, move the upper two lines in such a way that the part of its projection which contains all of the intersections (in the projection) passes

Rotate this picture by 90° clockwise, we obtain the mirror image of the original picture.

Amphicheiral examples

- Can lines be linked?
- Combing lines
- No parallel lines
- Equivalence of links made of skew lines
- Pair of lines
- Orientations and Semi-Orientations
- Linking number
- Triples of lines
- Parallelepiped
- Deforming parallelepiped
- Linking number of a triple

Amphicheiral and Nonamphicheiral

- Amphicheirality problems
- Nonamphicheiral examples
- **Amphicheiral examples**
- Amphicheiral examples
- Four lines
- Five lines

To answer Question 4, construct amphicheiral links of p lines when $p \not\equiv 3 \pmod{4}$. The simplest example ($p = 4$):

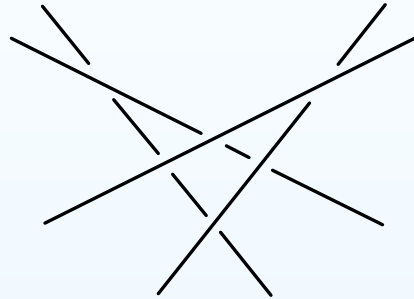

To prove amphicheirality of the link, move the upper two lines in such a way that the part of its projection which contains all of the intersections (in the projection) passes over and above the projection of the other two lines:

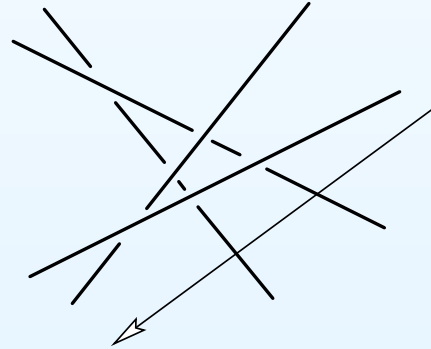

Rotate this picture by 90° clockwise, we obtain the mirror image of the original picture. For any even number p , take two sets of $p/2$ lines, one behind the other.

Amphicheiral examples

- Can lines be linked?
- Combing lines
- No parallel lines
- Equivalence of links made of skew lines
- Pair of lines
- Orientations and Semi-Orientations
- Linking number
- Triples of lines
- Parallelepiped
- Deforming parallelepiped
- Linking number of a triple

Amphicheiral and Nonamphicheiral

- Amphicheirality problems
- Nonamphicheiral examples
- **Amphicheiral examples**
- Amphicheiral examples
- Four lines
- Five lines

To answer Question 4, construct amphicheiral links of p lines when $p \not\equiv 3 \pmod{4}$. The simplest example ($p = 4$):

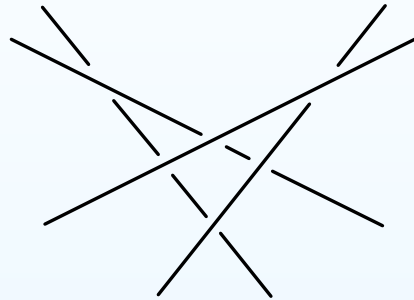

To prove amphicheirality of the link, move the upper two lines in such a way that the part of its projection which contains all of the intersections (in the projection) passes over and above the projection of the other two lines:

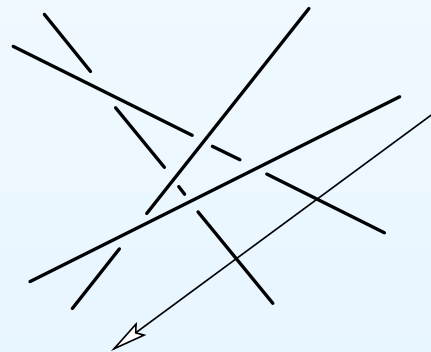

Rotate this picture by 90° clockwise, we obtain the mirror image of the original picture. For any even number p , take two sets of $p/2$ lines, one behind the other.

Take the lines of the upper set from the sequence of nonamphicheiral links constructed earlier.

Amphicheiral examples

- Can lines be linked?
- Combing lines
- No parallel lines
- Equivalence of links made of skew lines
- Pair of lines
- Orientations and Semi-Orientations
- Linking number
- Triples of lines
- Parallelepiped
- Deforming parallelepiped
- Linking number of a triple

Amphicheiral and Nonamphicheiral

- Amphicheirality problems
- Nonamphicheiral examples
- **Amphicheiral examples**
- Amphicheiral examples
- Four lines
- Five lines

To answer Question 4, construct amphicheiral links of p lines when $p \not\equiv 3 \pmod{4}$. The simplest example ($p = 4$):

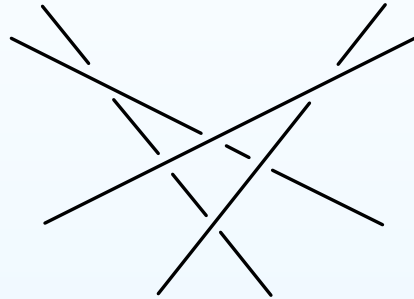

To prove amphicheirality of the link, move the upper two lines in such a way that the part of its projection which contains all of the intersections (in the projection) passes over and above the projection of the other two lines:

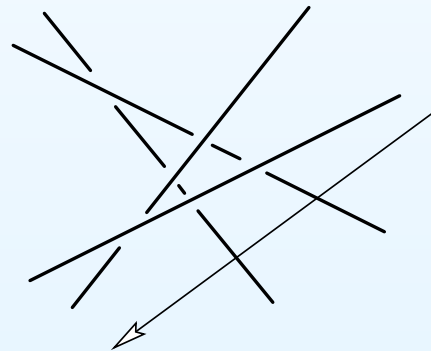

Rotate this picture by 90° clockwise, we obtain the mirror image of the original picture. For any even number p , take two sets of $p/2$ lines, one behind the other.

Take the lines of the upper set from the sequence of nonamphicheiral links constructed earlier. The other $p/2$ lines is obtained from the first ones by rotating and then reflecting in a mirror.

Amphicheiral examples

- Can lines be linked?
- Combing lines
- No parallel lines
- Equivalence of links made of skew lines
- Pair of lines
- Orientations and Semi-Orientations
- Linking number
- Triples of lines
- Parallelepiped
- Deforming parallelepiped
- Linking number of a triple

Amphicheiral and Nonamphicheiral

- Amphicheirality problems
- Nonamphicheiral examples
- Amphicheiral examples
- **Amphicheiral examples**
- Four lines
- Five lines

Exercise. Construct similar examples for $p \equiv 1 \pmod{4}$, i.e., amphicheiral links of $p = 4k + 1$ lines.

Amphicheiral examples

- Can lines be linked?
- Combing lines
- No parallel lines
- Equivalence of links made of skew lines
- Pair of lines
- Orientations and Semi-Orientations
- Linking number
- Triples of lines
- Parallelepiped
- Deforming parallelepiped
- Linking number of a triple

Amphicheiral and Nonamphicheiral

- Amphicheirality problems
- Nonamphicheiral examples
- Amphicheiral examples
- **Amphicheiral examples**
- Four lines
- Five lines

Exercise. Construct similar examples for $p \equiv 1 \pmod{4}$, i.e., amphicheiral links of $p = 4k + 1$ lines.

Here is the simplest link of this sort, with $p = 5$:

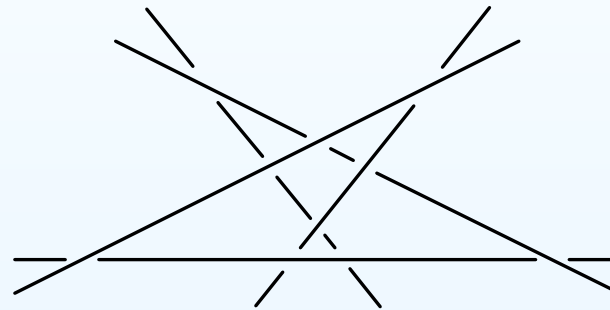

Amphicheiral examples

- Can lines be linked?
- Combing lines
- No parallel lines
- Equivalence of links made of skew lines
- Pair of lines
- Orientations and Semi-Orientations
- Linking number
- Triples of lines
- Parallelepiped
- Deforming parallelepiped
- Linking number of a triple

Amphicheiral and Nonamphicheiral

- Amphicheirality problems
- Nonamphicheiral examples
- Amphicheiral examples
- **Amphicheiral examples**
- Four lines
- Five lines

Exercise. Construct similar examples for $p \equiv 1 \pmod{4}$, i.e., amphicheiral links of $p = 4k + 1$ lines.

Here is the simplest link of this sort, with $p = 5$:

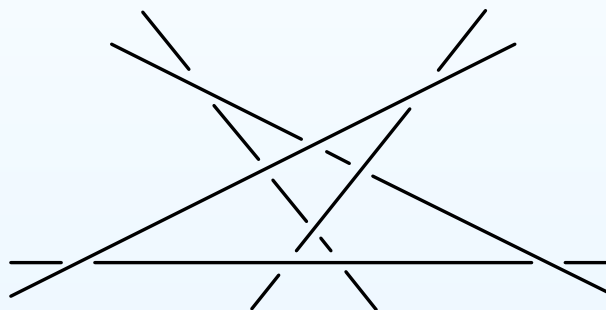

Exercise. Prove, at least, that this link is amphicheiral.

Four lines

- Can lines be linked?
- Combing lines
- No parallel lines
- Equivalence of links made of skew lines
- Pair of lines
- Orientations and Semi-Orientations
- Linking number
- Triples of lines
- Parallelepiped
- Deforming parallelepiped
- Linking number of a triple

Amphicheiral and Nonamphicheiral

- Amphicheirality problems
- Nonamphicheiral examples
- Amphicheiral examples
- Amphicheiral examples
- **Four lines**
- Five lines

Links of four lines:

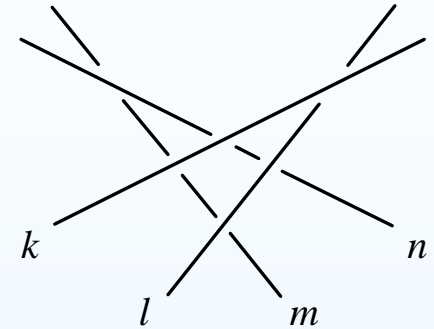
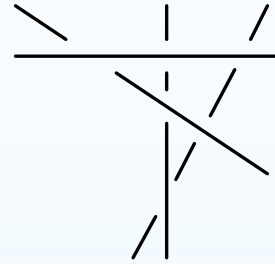
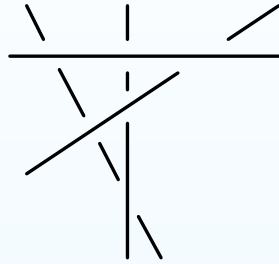

Four lines

- Can lines be linked?
- Combing lines
- No parallel lines
- Equivalence of links made of skew lines
- Pair of lines
- Orientations and Semi-Orientations
- Linking number
- Triples of lines
- Parallelepiped
- Deforming parallelepiped
- Linking number of a triple

Amphicheiral and Nonamphicheiral

- Amphicheirality problems
- Nonamphicheiral examples
- Amphicheiral examples
- Amphicheiral examples
- **Four lines**
- Five lines

Links of four lines:

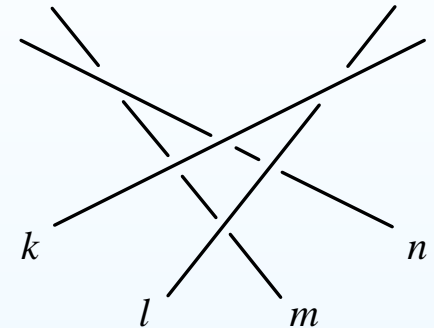
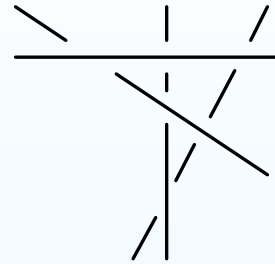
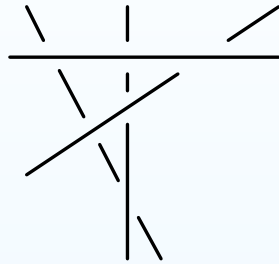

Theorem. Any link of four lines is isotopic to one of these links.

Four lines

- Can lines be linked?
- Combing lines
- No parallel lines
- Equivalence of links made of skew lines
- Pair of lines
- Orientations and Semi-Orientations
- Linking number
- Triples of lines
- Parallelepiped
- Deforming parallelepiped
- Linking number of a triple

Amphicheiral and Nonamphicheiral

- Amphicheirality problems
- Nonamphicheiral examples
- Amphicheiral examples
- Amphicheiral examples
- **Four lines**
- Five lines

Links of four lines:

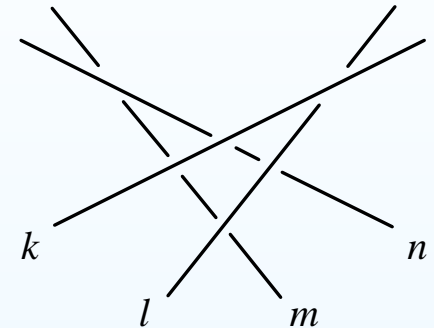
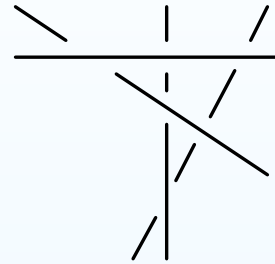
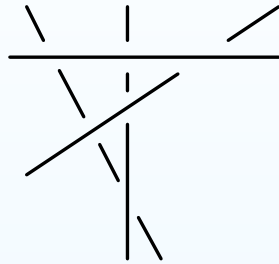

Theorem. Any link of four lines is isotopic to one of these links.

Proof. Take an arbitrary link of four lines.

Four lines

- Can lines be linked?
- Combing lines
- No parallel lines
- Equivalence of links made of skew lines
- Pair of lines
- Orientations and Semi-Orientations
- Linking number
- Triples of lines
- Parallelepiped
- Deforming parallelepiped
- Linking number of a triple

Amphicheiral and Nonamphicheiral

- Amphicheirality problems
- Nonamphicheiral examples
- Amphicheiral examples
- Amphicheiral examples
- **Four lines**
- Five lines

Links of four lines:

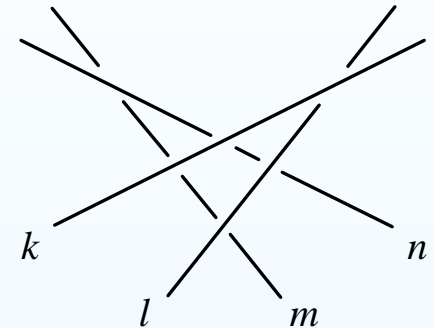
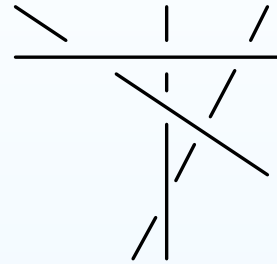
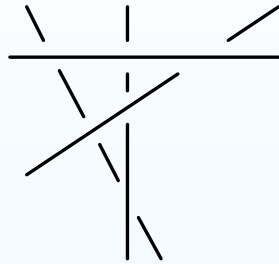

Theorem. Any link of four lines is isotopic to one of these links.

Proof. Take an arbitrary link of four lines. By moving it slightly, if necessary, make three of the four lines (it makes no difference which three) do not lie in parallel planes.

Four lines

- Can lines be linked?
- Combing lines
- No parallel lines
- Equivalence of links made of skew lines
- Pair of lines
- Orientations and Semi-Orientations
- Linking number
- Triples of lines
- Parallelepiped
- Deforming parallelepiped
- Linking number of a triple

Amphicheiral and Nonamphicheiral

- Amphicheirality problems
- Nonamphicheiral examples
- Amphicheiral examples
- Amphicheiral examples
- **Four lines**
- Five lines

Links of four lines:

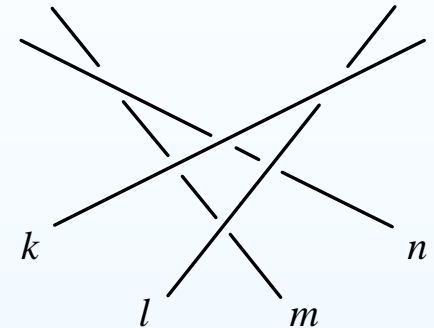
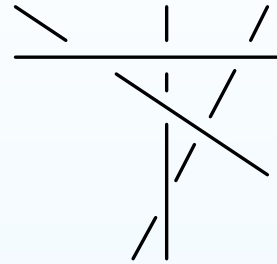
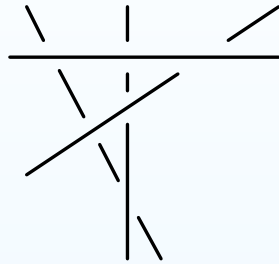

Theorem. Any link of four lines is isotopic to one of these links.

Proof. Take an arbitrary link of four lines. By moving it slightly, if necessary, make three of the four lines (it makes no difference which three) do not lie in parallel planes. Construct a hyperboloid through these three lines.

Four lines

- Can lines be linked?
- Combing lines
- No parallel lines
- Equivalence of links made of skew lines
- Pair of lines
- Orientations and Semi-Orientations
- Linking number
- Triples of lines
- Parallelepiped
- Deforming parallelepiped
- Linking number of a triple

Amphicheiral and Nonamphicheiral

- Amphicheirality problems
- Nonamphicheiral examples
- Amphicheiral examples
- Amphicheiral examples
- **Four lines**
- Five lines

Links of four lines:

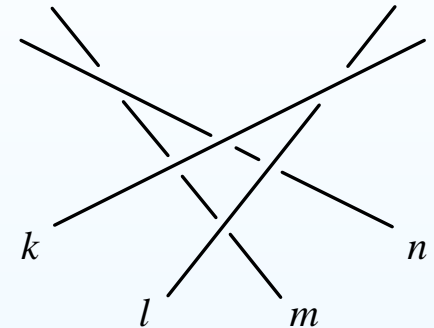
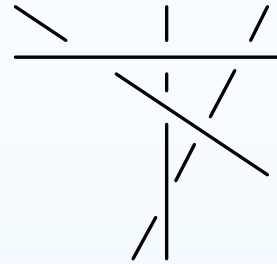
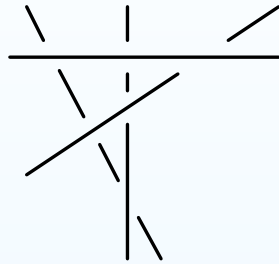

Theorem. Any link of four lines is isotopic to one of these links.

Proof. Take an arbitrary link of four lines. The fourth line:

Four lines

- Can lines be linked?
- Combing lines
- No parallel lines
- Equivalence of links made of skew lines
- Pair of lines
- Orientations and Semi-Orientations
- Linking number
- Triples of lines
- Parallelepiped
- Deforming parallelepiped
- Linking number of a triple

Amphicheiral and Nonamphicheiral

- Amphicheirality problems
- Nonamphicheiral examples
- Amphicheiral examples
- Amphicheiral examples
- **Four lines**
- Five lines

Links of four lines:

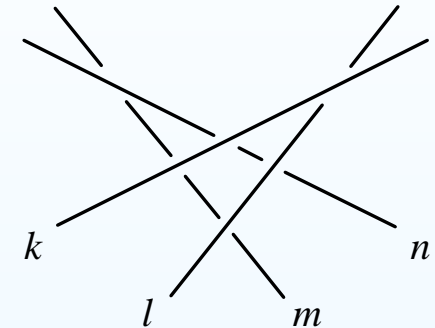
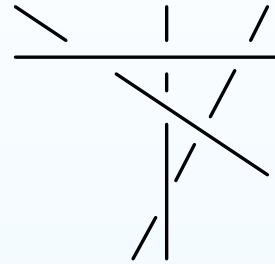
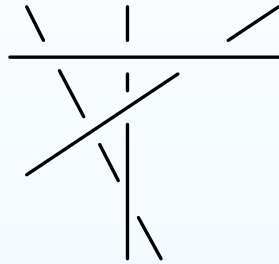

Theorem. Any link of four lines is isotopic to one of these links.

Proof. Take an arbitrary link of four lines. The fourth line:
1. either does not intersect the hyperboloid

Four lines

- Can lines be linked?
- Combing lines
- No parallel lines
- Equivalence of links made of skew lines
- Pair of lines
- Orientations and Semi-Orientations
- Linking number
- Triples of lines
- Parallelepiped
- Deforming parallelepiped
- Linking number of a triple

Amphicheiral and Nonamphicheiral

- Amphicheirality problems
- Nonamphicheiral examples
- Amphicheiral examples
- Amphicheiral examples
- **Four lines**
- Five lines

Links of four lines:

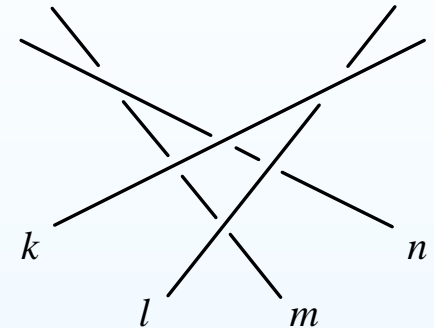
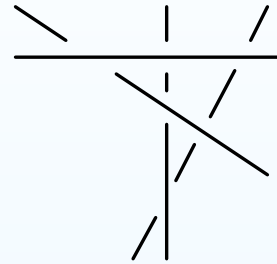
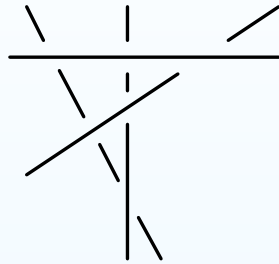

Theorem. Any link of four lines is isotopic to one of these links.

Proof. Take an arbitrary link of four lines. The fourth line:

1. either does not intersect the hyperboloid
2. or intersect it in a single point,

Four lines

- Can lines be linked?
- Combing lines
- No parallel lines
- Equivalence of links made of skew lines
- Pair of lines
- Orientations and Semi-Orientations
- Linking number
- Triples of lines
- Parallelepiped
- Deforming parallelepiped
- Linking number of a triple

Amphicheiral and Nonamphicheiral

- Amphicheirality problems
- Nonamphicheiral examples
- Amphicheiral examples
- Amphicheiral examples
- **Four lines**
- Five lines

Links of four lines:

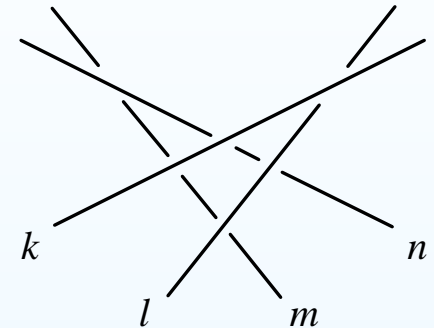
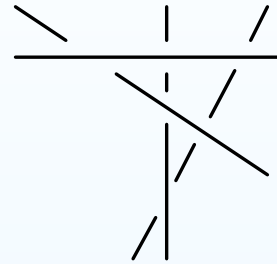
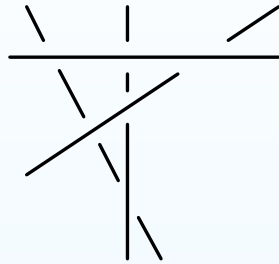

Theorem. Any link of four lines is isotopic to one of these links.

Proof. Take an arbitrary link of four lines. The fourth line:

1. either does not intersect the hyperboloid
2. or intersect it in a single point,
3. or intersect it in two points,

Four lines

- Can lines be linked?
- Combing lines
- No parallel lines
- Equivalence of links made of skew lines
- Pair of lines
- Orientations and Semi-Orientations
- Linking number
- Triples of lines
- Parallelepiped
- Deforming parallelepiped
- Linking number of a triple

Amphicheiral and Nonamphicheiral

- Amphicheirality problems
- Nonamphicheiral examples
- Amphicheiral examples
- Amphicheiral examples
- **Four lines**
- Five lines

Links of four lines:

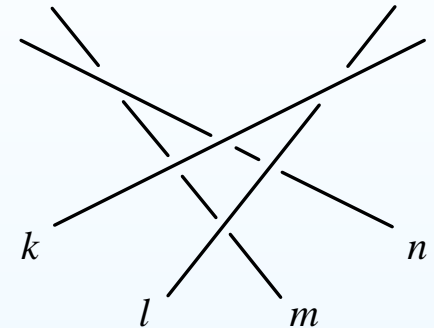
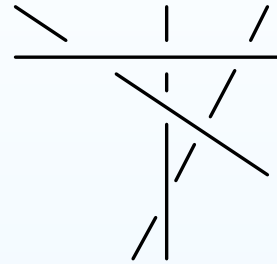
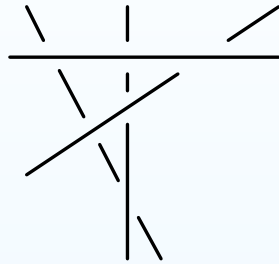

Theorem. Any link of four lines is isotopic to one of these links.

Proof. Take an arbitrary link of four lines. The fourth line:

1. either does not intersect the hyperboloid
2. or intersect it in a single point,
3. or intersect it in two points,
4. or lies on the hyperboloid.

Four lines

- Can lines be linked?
- Combing lines
- No parallel lines
- Equivalence of links made of skew lines
- Pair of lines
- Orientations and Semi-Orientations
- Linking number
- Triples of lines
- Parallelepiped
- Deforming parallelepiped
- Linking number of a triple

Amphicheiral and Nonamphicheiral

- Amphicheirality problems
- Nonamphicheiral examples
- Amphicheiral examples
- Amphicheiral examples
- **Four lines**
- Five lines

Links of four lines:

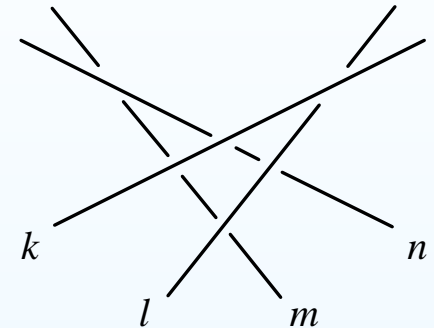
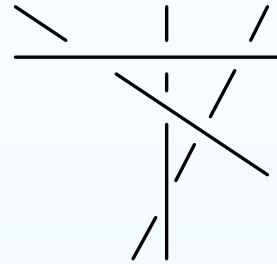
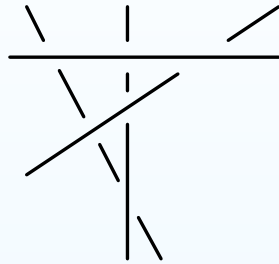

Theorem. Any link of four lines is isotopic to one of these links.

Proof. Take an arbitrary link of four lines. The fourth line:

1. either does not intersect the hyperboloid
2. or intersect it in a single point,
3. or intersect it in two points,
4. or lies on the hyperboloid.

In the last case the link is isotopic either to the left or the center link.

Four lines

- Can lines be linked?
- Combing lines
- No parallel lines
- Equivalence of links made of skew lines
- Pair of lines
- Orientations and Semi-Orientations
- Linking number
- Triples of lines
- Parallelepiped
- Deforming parallelepiped
- Linking number of a triple

Amphicheiral and Nonamphicheiral

- Amphicheirality problems
- Nonamphicheiral examples
- Amphicheiral examples
- Amphicheiral examples
- **Four lines**
- Five lines

Links of four lines:

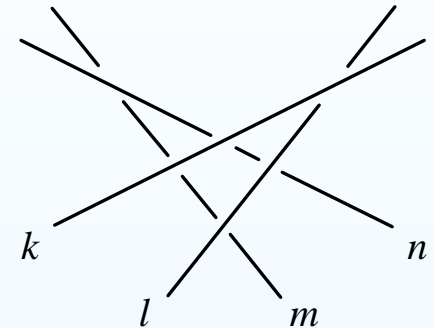
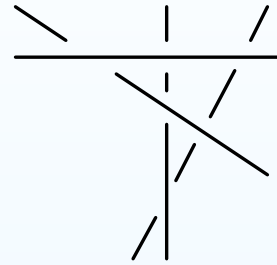
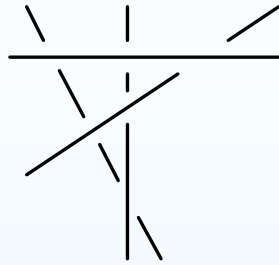

Theorem. Any link of four lines is isotopic to one of these links.

Proof. Take an arbitrary link of four lines. The fourth line:

1. either does not intersect the hyperboloid
2. or intersect it in a single point,
3. or intersect it in two points,

If the fourth line does not intersect the hyperboloid, then it can be brought in toward the hyperboloid until it is tangent to the hyperboloid, i.e., the case 1 is reduced to case 2.

Four lines

- Can lines be linked?
- Combing lines
- No parallel lines
- Equivalence of links made of skew lines
- Pair of lines
- Orientations and Semi-Orientations
- Linking number
- Triples of lines
- Parallelepiped
- Deforming parallelepiped
- Linking number of a triple

Amphicheiral and Nonamphicheiral

- Amphicheirality problems
- Nonamphicheiral examples
- Amphicheiral examples
- Amphicheiral examples
- **Four lines**
- Five lines

Links of four lines:

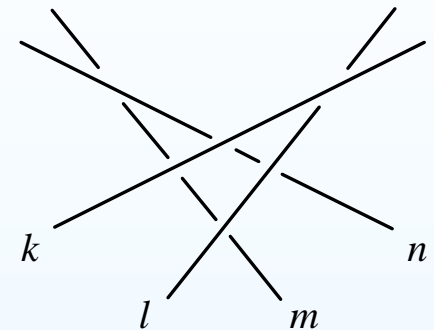
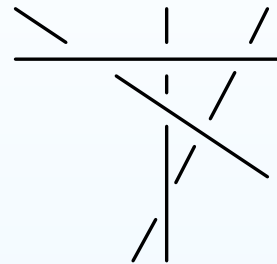
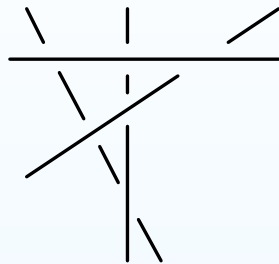

Theorem. Any link of four lines is isotopic to one of these links.

Proof. Take an arbitrary link of four lines. The fourth line:

2. or intersect it in a single point,

3. or intersect it in two points,

The case 2 reduces to 4 or 3:

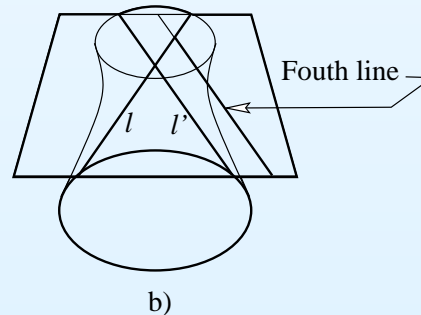
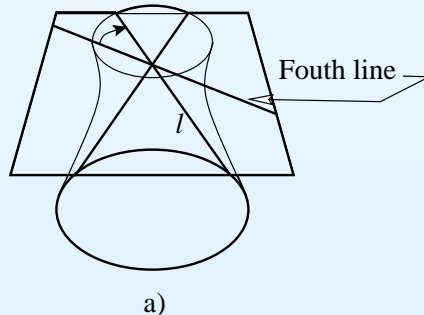

Four lines

- Can lines be linked?
- Combing lines
- No parallel lines
- Equivalence of links made of skew lines
- Pair of lines
- Orientations and Semi-Orientations
- Linking number
- Triples of lines
- Parallelepiped
- Deforming parallelepiped
- Linking number of a triple

Amphicheiral and Nonamphicheiral

- Amphicheirality problems
- Nonamphicheiral examples
- Amphicheiral examples
- Amphicheiral examples
- **Four lines**
- Five lines

Links of four lines:

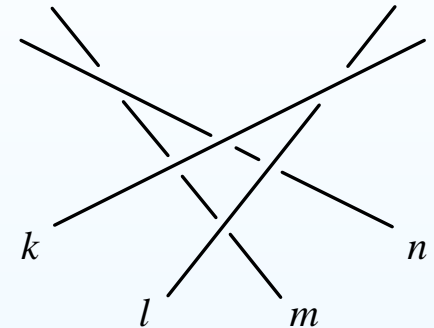
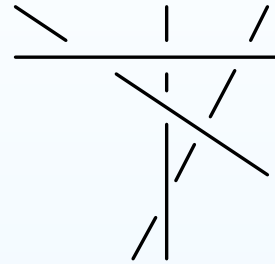
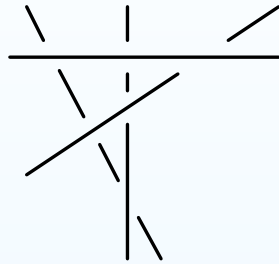

Theorem. Any link of four lines is isotopic to one of these links.

Proof. Take an arbitrary link of four lines. The fourth line:
3. or intersect it in two points,

If the fourth line intersects the hyperboloid in two points, then everything depends on whether these points are in the same part of the hyperboloid into which the first three lines divide it, or are in different parts (the hyperboloid is divided into three sections).

Four lines

- Can lines be linked?
- Combing lines
- No parallel lines
- Equivalence of links made of skew lines
- Pair of lines
- Orientations and Semi-Orientations
- Linking number
- Triples of lines
- Parallelepiped
- Deforming parallelepiped
- Linking number of a triple

Amphicheiral and Nonamphicheiral

- Amphicheirality problems
- Nonamphicheiral examples
- Amphicheiral examples
- Amphicheiral examples
- **Four lines**
- Five lines

Links of four lines:

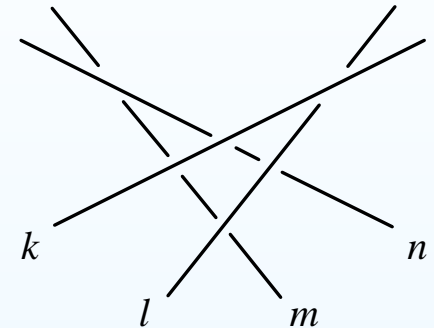
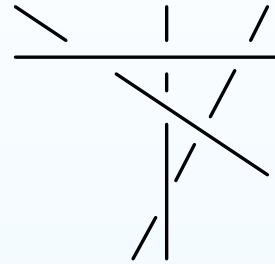
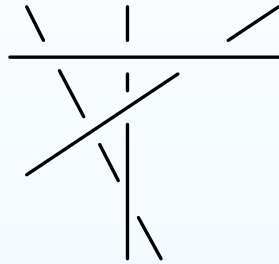

Theorem. Any link of four lines is isotopic to one of these links.

Proof. Take an arbitrary link of four lines. The fourth line:

3. or intersect it in two points,

If the points are in the same part, then the fourth line can be placed on the hyperboloid without the first three lines interfering.

Four lines

- Can lines be linked?
- Combing lines
- No parallel lines
- Equivalence of links made of skew lines
- Pair of lines
- Orientations and Semi-Orientations
- Linking number
- Triples of lines
- Parallelepiped
- Deforming parallelepiped
- Linking number of a triple

Amphicheiral and Nonamphicheiral

- Amphicheirality problems
- Nonamphicheiral examples
- Amphicheiral examples
- Amphicheiral examples
- **Four lines**
- Five lines

Links of four lines:

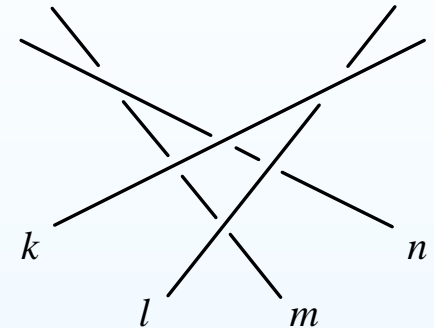
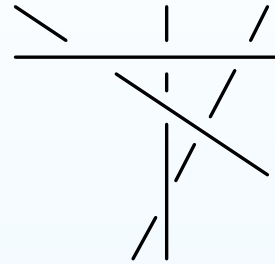
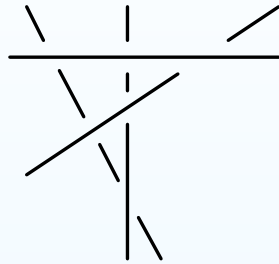

Theorem. Any link of four lines is isotopic to one of these links.

Proof. Take an arbitrary link of four lines. The fourth line:
3. or intersect it in two points,

If the points are in the same part, then the fourth line can be placed on the hyperboloid without the first three lines interfering. Then the fourth line becomes a generatrix, and we are in case 4.

Four lines

- Can lines be linked?
- Combing lines
- No parallel lines
- Equivalence of links made of skew lines
- Pair of lines
- Orientations and Semi-Orientations
- Linking number
- Triples of lines
- Parallelepiped
- Deforming parallelepiped
- Linking number of a triple

Amphicheiral and Nonamphicheiral

- Amphicheirality problems
- Nonamphicheiral examples
- Amphicheiral examples
- Amphicheiral examples
- **Four lines**
- Five lines

Links of four lines:

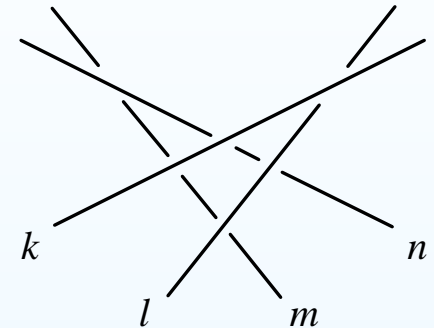
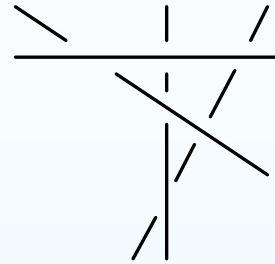
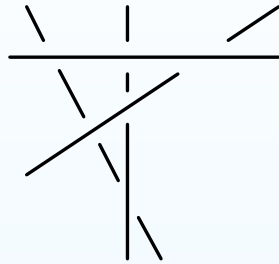

Theorem. Any link of four lines is isotopic to one of these links.

Proof. Take an arbitrary link of four lines. The fourth line:

3. or intersect it in two points,

If the fourth line intersects the hyperboloid in different parts, then the link is isotopic to the rightmost one.

Five lines

- Can lines be linked?
- Combing lines
- No parallel lines
- Equivalence of links made of skew lines
- Pair of lines
- Orientations and Semi-Orientations
- Linking number
- Triples of lines
- Parallelepiped
- Deforming parallelepiped
- Linking number of a triple

Amphicheiral and Nonamphicheiral

- Amphicheirality problems
- Nonamphicheiral examples
- Amphicheiral examples
- Amphicheiral examples
- Four lines
- Five lines

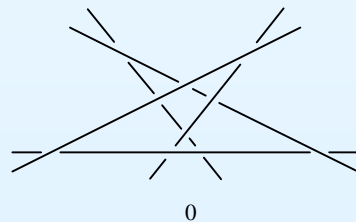
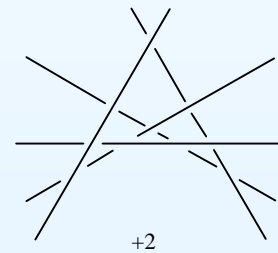
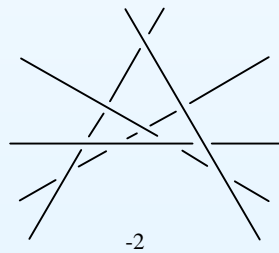
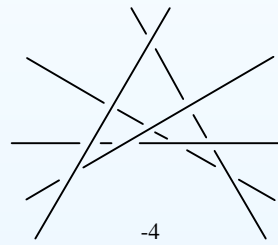
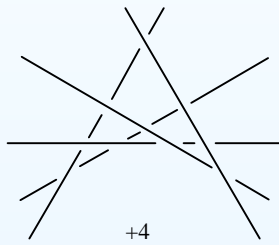
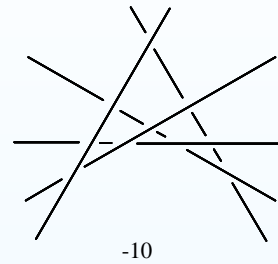
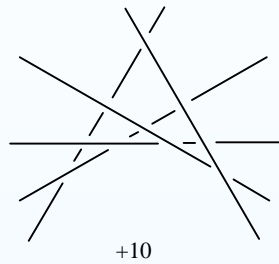

Six lines

- Can lines be linked?
- Combing lines
- No parallel lines
- Equivalence of links made of skew lines
- Pair of lines
- Orientations and Semi-Orientations
- Linking number
- Triples of lines
- Parallelepiped
- Deforming parallelepiped
- Linking number of a triple

Amphicheiral and Nonamphicheiral

- Amphicheirality problems
- Nonamphicheiral examples
- Amphicheiral examples
- Amphicheiral examples
- Four lines
- Five lines

